

5

1:





2.





•

•

•

•

•

•

-

-

-

-

-

-

-

-

-

¿ €



# 第 1

## 1.1

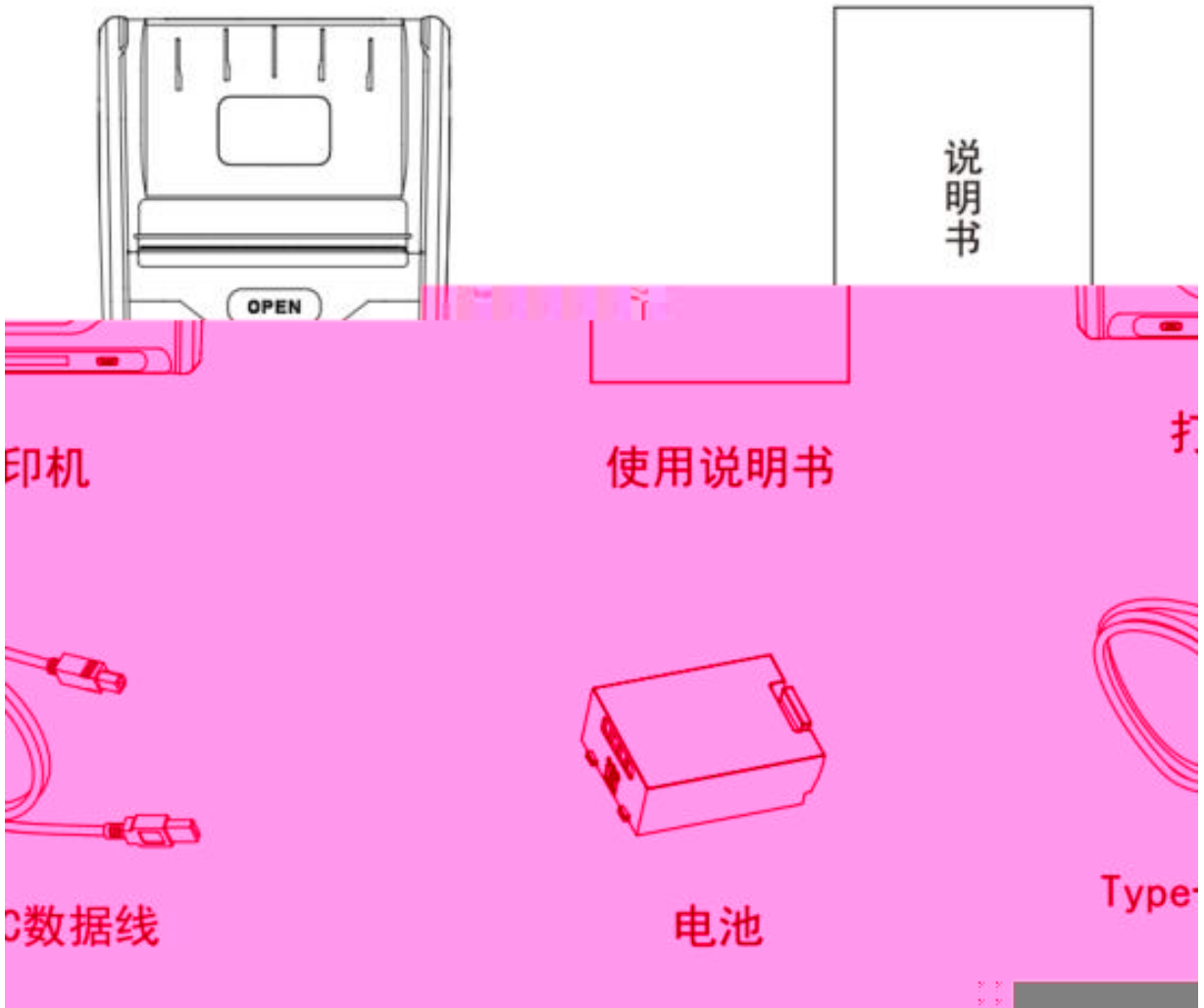

## 1.2

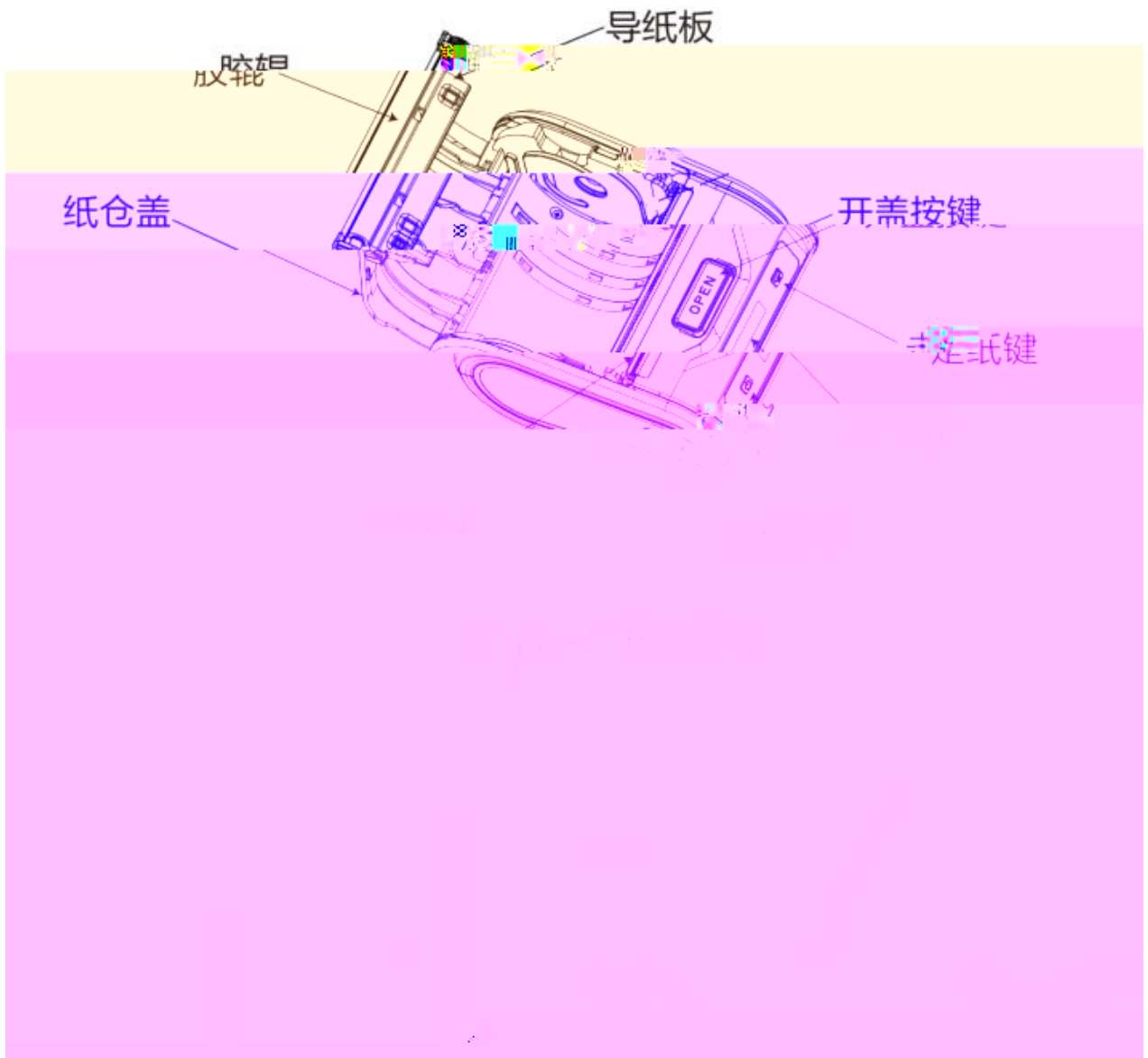



# 1.3

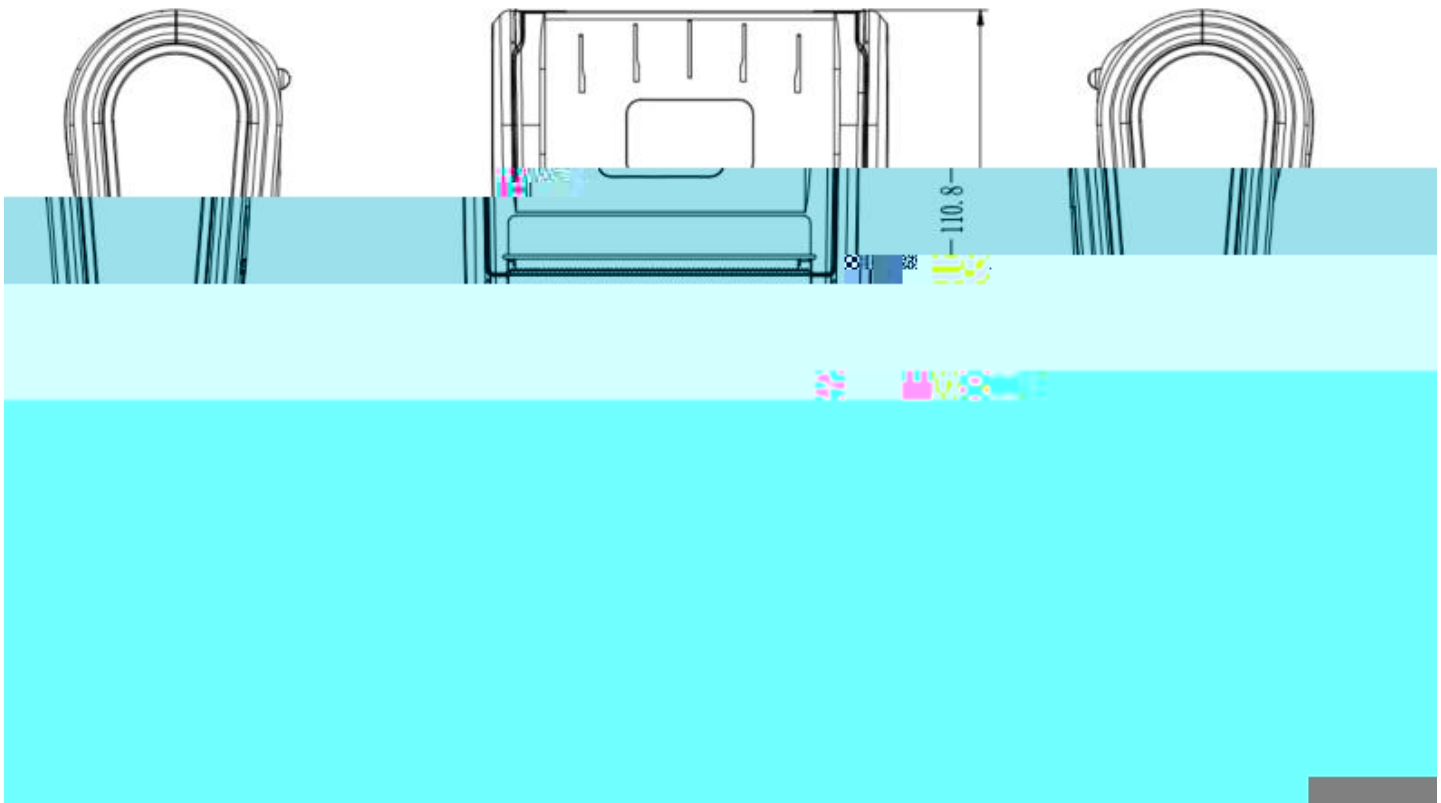
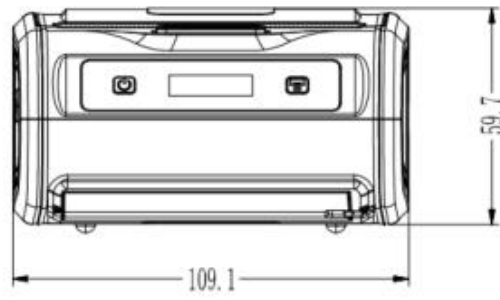

## 第 2

# 第 3

## 3.1

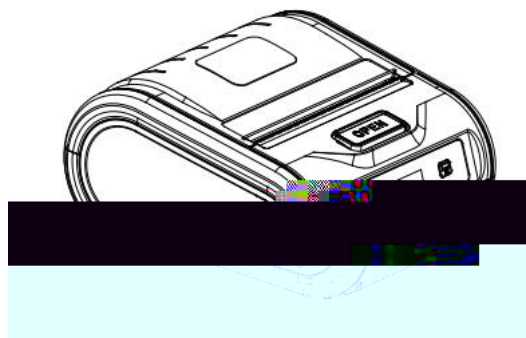
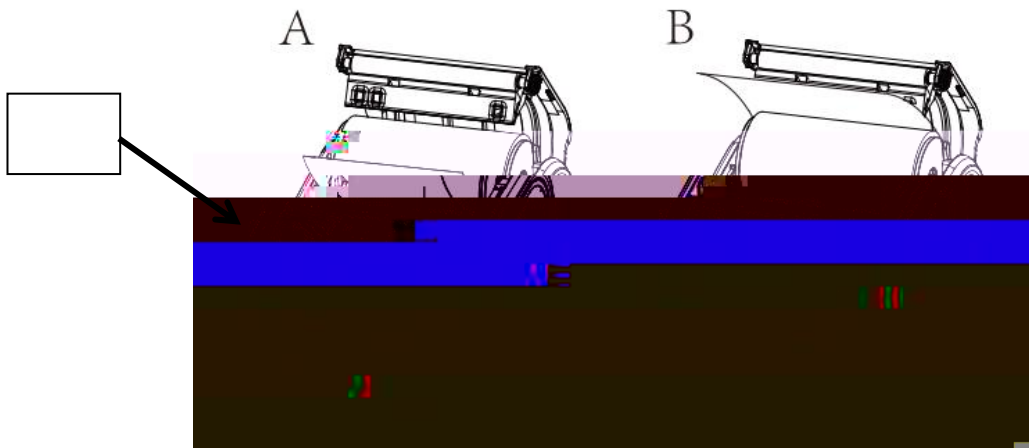
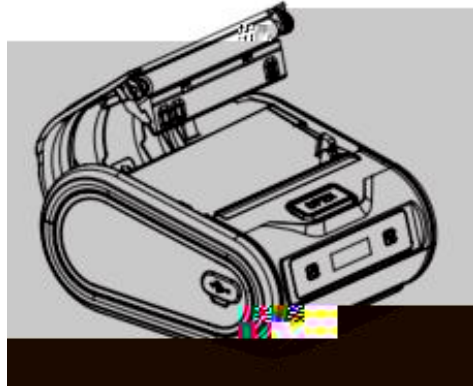

### 3.2

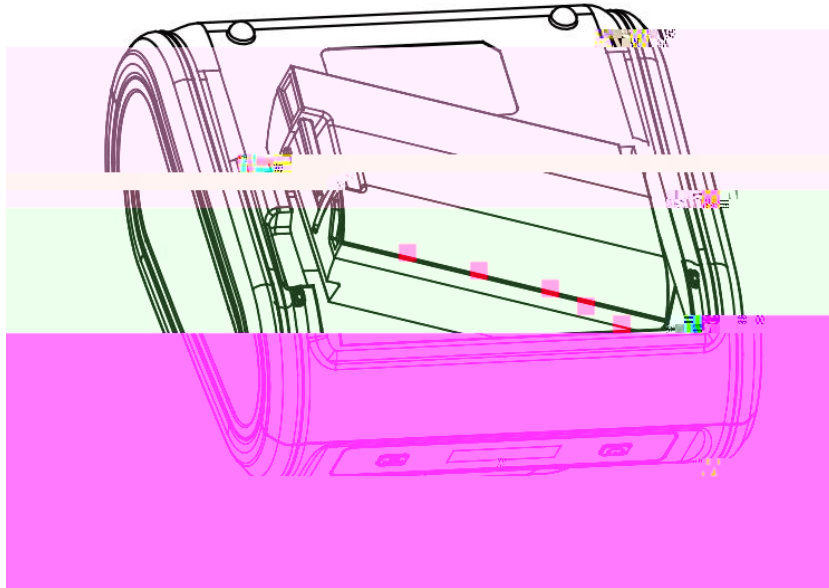

5V = 2A I



警告

如果使用非我公司提供的充电器，可能损坏打印机。



注意

充电中请勿取出电池。

## 1. 安卓手机使用方法

第一步: 打开手机蓝牙并打开打印机电源

第二步: 打开相应APP, 连接打印机打印即可



# 4



➤

➤

➤

➤

➤

➤



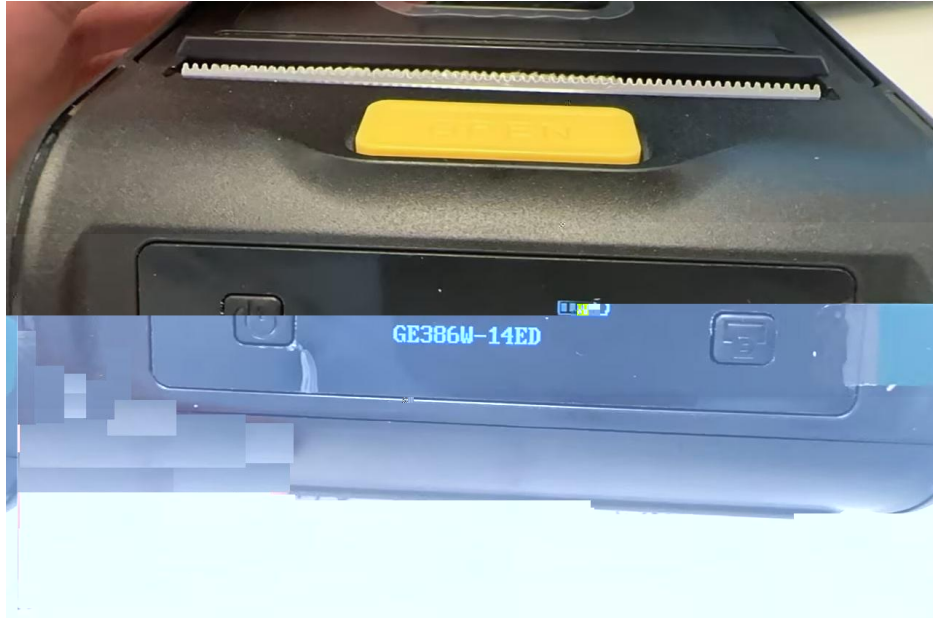

# 第 章

---





故障现象	故障原因	解决方法
屏幕显示（缺纸）	打印机缺纸	请正确安装打印纸
打印机打印时只走纸，没有打印出数据	打印纸装反	请将打印纸重新换一个方向安装
打印机打印模糊	打印机长期不清理导致机芯被脏物污染	需要清理打印机芯
	打印纸显色不良	请设置打印浓度或使用显色效果更好的打印纸
屏幕显示（请关闭纸盒盖）	纸盒盖未关好	合上纸盒盖
	打印纸质量不佳	请选择保存期较长的第一级打印纸
打印机单据在几个月甚至几周内字迹就模糊了	单据保持的环境温度过高	请于常温（20℃左右）下存放
打印机自动关机	电池电量已经耗尽	请立即充电

1

	Pb	Hg	Cd	Cr6+	PBB	PBDE
	X	O	O	O	O	O
	X	O	O	O	O	O
	O	O	O	O	O	O
	X	O	O	O	O	O
	O	O	O	O	O	O
	O	O	O	O	O	O

