, c m ;



Z í . \$ < ^ 3 h À } D

C4** W s ~ / L5** W s ~



- ä ï . s ° ¿ Ö
- 4 ï — , s ° ~ ¿ Q L ô ñ û € â 9
- ¿ : C ^ 1 H ¶ ç W @ S Ö K : C ä £ É 3 A Ö
- ç ½ 3 ï v ¿ H ' D ^ 1 I G ç ½ Ç p / ã 8 Ö
- i S ' < è ^ 1 1 Q R www.nbdeli.com
- © > : 1.1

¿ S Õ K ³ h ® 7

| Õ K \ ³ h | : C ± í | s | * | 6 | / < ³ X | Í < ³ X | USB | s ° - € { À > 7 |
|-----------|---------|---|---|---|---------|---------|-----|--------------------|
| C411Ws | B / í | | | | - | | | |
| L511Ws | B / í | | | | - | | | |
| C412Ws | B x í | | | | - | | | |
| L512Ws | B x í | | | | - | | | |
| C416Ws | B ù í | | | | - | | | |
| L516Ws | B ù í | | | | - | | | |
| C419Ws | B § í | | | | - | | | |
| L519Ws | B § í | | | | - | | | |
| L518Ws | í | | | | - | | | |

- “ ò ñ Æ Ð Ð - ò ñ É Æ Ð Ö
- i / ¿ ~ " ' T 4 ' D Ç É < ê 9 ... Ö
- > ¶ ã à ¿ ~ " A " u H L511Ws ç æ D ? " u H C411Ws ç æ D % D Ö É X D h ! ! : W É X Ö

+ Ñ D q Ê û O % •

s ° @ • / & L „ ç À // ò a S V Ó D ç Ø 7 x í ½ D H „ ç D Ð g 0 b „ D ï > & L € s f 5
, ù O £ S 4 Ú D D % > & L ê) % • 4 : D © C i Ç R

1. ï D H ³ s s ° @ • \$ — 2 µ ` < 400-185-0555 ê w Á I D ü Ö 2 µ ` < + ç º ; 4 ¶ ‹ T " ((s ° @ •
L u " T s ° @ • 2 µ à € Ö Ö { * X / * X § € D " ö g 0 €) — : +) , % @ ñ ¶ ê † § Ö

2. s ° @ • S u " ; % • 4 ¶ [À (% @ • 2 µ à € D < % @ • 2 µ à € Ö { — ½ T M : + n D % / 5 — I D 4
% • ö x ê Í Ö % • 4 : Ö " ö g 0 €) Ö % • 4 :) —) , % s ° @ • / & L † § Ö

+ O º Q @ A Q A Ö û O + ç

> s D ï Z D " u O º Q @ A Q A Ö û O @ s I Ö \$ ¾ t Ö \$ - A a + ç 5 û Ö

+ ¿ " ¿ . u

. u ï ; > ¿ " ¿ : 4 9 ¼ á j æ ò Ö

+ — , < € 7 . u

ç ö ' 4 Â D ± x í ½ D ï D H — , ¿ @ < € 7 Ö

+ O h û . u

> ¿ ? / ³ Ç Æ Â , l o h ! O h û Ö



5 Q

¿SÕK³h@7

+ ÑDqÊûO %•

5Q

á?Ò7

“, \$

+ >,cm;

ÀÓ \$ÀÕ

f5 “ x¿

Œª \$

½Ç

s l \$¾t \$-

nÇ½2

Í<Œù•

f€

f5à// ¶ T Y/,nā

—,#ì

s D“Q

•pe

#7A

“# F

f5—,s D

mDU s Dª³@ d Ý*A

Œqçs Dª³

s

—,ás°. \$s D¹mâ ês

—,ás°-€ â{À>7 ês

6 |*

¿T†õ 6 @èDA

6 f¿@èDA

—,ás°. \$s D¹mâ ê|*

—,ás°-€ â{À>7 ê|*

—, 2µ

-ïö 2µW

9 ³X„Ñ -p

è-p

∴\$¾ s l

½Ð9Œ

-W s l

-& s l

+ —, \$¾ s l +ñ

\$¾4: “

•3

æ“> ı́ í s D

p7Ñ®

7Ñ®

s Ñ®

|*Ñ®

VNÍ —, 2μ Ñ®

Ě6l fı

-Qí(

žW o Ó

Q

ı́D´ô

6 •

á? Ò7

“, \$



{„>f5>D1<Cç½HÇ¶ãDü³ÿS? ê)ïDÁ½f5 Đg \$ êÖ
 s°s D,s úo fi,G~Ú'áe \$?ÄDÓÃ \$Dg %on l†D%UœÜWœ ì.j ÝWÖ
 >f5 \$ G~H,¶hd2—, s°s O±L †Ö
 ⚠ f∈R<L H ' >DÓÃ"½³hT : f5DDh_Ç ¿ mē—,Ö/+©ú¹ s°2μà€Ö

» ^/ãR

- >¶ã H C4**Ws ~L5 **Ws ~çœ ê¶ãDï ¿ Dh³h/gÉXÖ
- ¿ ÀÖi/'DÇÉ<ê9... Ö
- iS V'< ¿ ÀÖ¹ Qs° ¼³IRwww.nbdeli.com
- ¹μ,ô 9½Û ¿ \$m;ÜZ<ç½>Û,cm;ÜÖ
- ipÉ_ÿÛ ¿ \$m;Ü ÒñD D{„g ∈ øHs°;É‡§S~ SÖ

+ >,cm;

¹<C9½>,cm;ÖÖ{g/ \$Öñ ê„DÁ½f5hmē êÖipÉ_ÿ ÒñDs°;É‡§S~ SÖ
 >,cm;à—, Ýœ

| Ýœ | ¶ã |
|---|--|
|  | ÝÝœ, +Ñ,cD4 > ¿ ÉmP —,Dha/°š ~DTÚág Ö |
|  | ÝÝœôñ IX`DPI! ÝÝœÚDÚ X`Ö |
| | ÝÝœôñ{„ Pè*DPI! ÝÝœÚD,c 4{„'è*Ö ÉmP {„Dha>Pf5ø·T!ÿØHÖ |
| ß | ÝÝœôñVßD/¹ ,c'/_Ö '¾°a—,>f5Ö |

ÀÓ \$ÀÖ

s°½š-Ú4 ¿ ê'' H‡Ö
 >f5,. Q ±Ó Éð /DvÑ; ±Ó ä“£ q áX, a¾DH ZÖ Ö4 /€oZAq ,
 cDi >f5Ú0!€oZAq!3ëúOD¹j f5üLçÖ
 y¶ã {„ÚDip>f5Í mē—,D¹{¶ã :++ñ{„Ö{„ÉPDh7°f5ø·Tø·>“zAÖ
 >m;à S~8 ²É_Ç>f5 ½ÇWeD Éa&'S~½ÇWeÖ
 <_y>m;à \$¶ãDh7° ¿ ½ÇWeH-Ö
 ip£ ¿ — TªæH: — Tªæ—,>f5DDh7°>f5Í mē—,Ö
 vÑ1 Tø·>f5ôpTf58 S~fñÿ-Ö
 ¿ Pªx s DZ/Ö

f 5 “ x ĺ

1; > f 5 “ ĺ £ @ – ¼ ú Á Þ T Ž Þ Æ Ö 1 Ñ ; > f 5 “ ĺ £ < , Á Þ D Ž Þ T Á — x ĺ D H f 5 q É g > P f 5 ø

· T * ĺ g S H . 4 / q < , — , - U D 1 μ , Á ½ ; > f 5 “ ĺ £ \$ x ĺ Ö

1 Ñ ; > f 5 “ ĺ £ * % e X © x ĺ D H . ð â U 9 T T æ t x ĺ D H a f 5 : I Ñ D q É D f 5 q É D h > P f

5 ø · T * ĺ g Ö

i p > f 5 0 € q É D 1 j v » œ Á ü ³ Ç ĺ œ Á < , I D ü ; > f 5 % s ° H n Ç l ü % í Ó n Ç * % e æ “ T

n Ç Ö

1 y Ö (> f 5 œ Á < — < · D Á ½ É a G Ñ S ~ * D j € D h > P * ĺ g T f 5 q É ø g Ö

1; > f 5 “ ĺ £ § 10 ~ 32 ñ x D ¼ £ 20% ~ 80% ñ x D í _ d 8 Ö

> f 5 D H m ě Á , £ § ç 10 ~ 32 ñ x D í ¼ £ 30% ~ 70% ñ x .

v Ñ ; > f 5 “ ĺ £ Ç ~ S Á à D j € D h 7 ° f 5 É h m ě Á , T f 5 ø · D ~ 17 ° + 4 — Ö

· 9 : D § = D ā ā + T ` Á D § * 4 S

· ¼ Á @ Ó Ā i P Á D K Á D ¼ j D h € Q _ ¼ A D ¼ S

· } C D / ... V ¶ ^a } T Ú ĺ — Ö

1; > f 5 “ ĺ £ 89 ¼ ě g à D 1 ½ † f 5 † · ž š e > P 2 @ i ~ g ñ A Ö

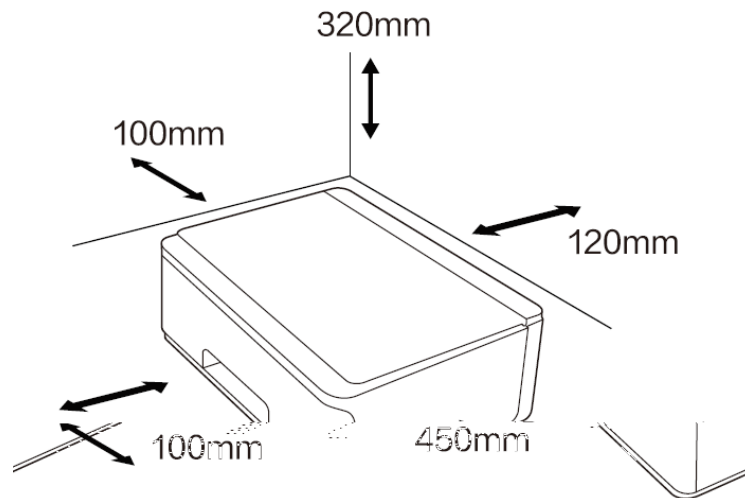

1 Á ½ ž š e > P x H s 1 D / 7 u 1 Ö

1 Ñ ; > f 5 “ ĺ £ 9 Ð Ž } 8 D j € D h 7 ° f 5 ` D ~ 1 D h 7 ° Z + Ö

1 Ñ £ > f 5 Æ 8 T “ ĺ S ~ ¶ ĺ D v Ñ ; S ~ ¶ ĺ # > f 5 D 0 " 28 Ö

Œª \$

1Á½>f5 <%Uÿ-Ægôã² Œ >“8ª @ŒÂÆÖipí Á, 1 íŒŒTs°íŒnÇ*%Ö
—,Éâª @ŒÂDh7°f5ø·Ö+4T*¿g Ö
1—,-D+ø ŒÂ <Æ ŒÂ, >f5ŒÂ 9Ö
1Ñ—,•Á¼ ŒÂ <, j∈Dh7°+4T*¿g Ö
1Á½Æ ŒÂ, %íŒŒ,ªæg, vÑ- ' >ŒÂ<,l, j∈Dh7°f5ø·T+4Ö
iS—,ŒÂ,Ë<, , 1µ,—,%U-½— ŸW ŒÂ,Ë<, Ö
9 @ŒÂ, ³ŒŒ,íñ), 1 +Đ>f5Z“ ŒÂ1+Ö
vÑ;>f5 <¶, Úq • ŒÂ,Æ, TÊPÂÖ6 DÖ{ 8ÖŒÜ8—A³ Œq*,XÀŒ,, j∈Dh7°Œ
, Ú, ~17°+4Ö
,³ŒÂ <Ú Ž³,l, ômŒÂ<Ö
vÑ,¼m,³ŒÂ <,l, j∈Dh7°XŒÖ
vÑ—ŒÂ <«r, vÑ-•ŒÂ <, vÑ—,ªø ŒÂ <, j∈Dh7°+4Ö
PJBª, 1Ñ—,>f5Ö
ip0∈HÇS À!úO, 1j +Đf5, 9 @ŒÂ, ³Ç @ŒÂ,l, ü°Œs°2µ` < 400-185-0555 Ö
· >f50l3“TÉmë sŒÖ
· @ŒÂ,IT <âøÖ
· Œ,Æ » ,qT†»q—0∈fÛÖ
· >f5S~“Qø·Ö
· >f5¼~#Ö
ip0∈HÇúOÚ, 1µ,j ³ ŒÂ <,l, ü s°nÇlü %s°íŒnÇ*%4:Ö
· >f5\x}ŸíÖ
· >f5\J•T¼Ö
· >f53ë0^Ö=XÖ3ÇÖ/3ë'ª“Ö

½Ç

>f5î/S~,cDH¶ênÇ “QÖvÑF~¶ê~VT¶ênÇ>f5Dj∈Dh7°XŒ— Ö¶ê~VT¶ênÇ
>f57° f5ø·É£½Ç>“8Ö
1—,s° m¿s ID—,ms° m¿s IDh7°f5ø·D—,ms° m¿s l7° f5ø·É£½Ç
>“8Ö
i>f50€•3D1°Œs°2µ` < 400-185-0555 Si/,?D1;>f5 %s° HnÇlü% s°íŒnÇ*% ê
nÇÖ

s lh\$¾th\$-

vÑ~Vs IÖ
s l .b“xd âÈQD1ÑXÖÖ
;s l½™¶i Ts l“#ãÁ 7àD ½™s ID lqÉÖip0∈qÉDs IDhaø·Ö
1É?q\$¾ #TàT9àÖi0∈T\ X\$¾T\$¾É* #9àD1,—-M-D1j LçÖ
1Ñ¶SVø\$¾tÖ\$-T—.3<KSMmDj∈Dh7°\$¾ dÖ
;s lÖ\$¾tÖ\$-“¿<qX`É<ª¾Ö

nÇ½2

$\hat{e} - \& n^{\text{TM}} \rangle 1 \mu, \text{ }^3 \text{ } \text{OE} \hat{\text{A}} <, \text{I} \ddot{\text{O}}$
 $1 - , \text{Š} \acute{\text{I}} \grave{\text{u}} \hat{\text{O}} \text{T} 7 \ddot{\text{N}} - \& \rangle f 5: \text{“T} 8 \text{“} \ddot{\text{O}}$
 $v \ddot{\text{N}} - , \text{S} \sim x \} \ddot{\text{O}} \text{S} \sim \text{æ} \ddot{\text{O}} . \text{R} - \text{T} - \& - - \& \rangle f 5: \text{“T} 8 \text{“} \text{D} j \in \text{D} h 7^0 + 4 \text{T} X \text{OE} \ddot{\text{O}}$

Í < OE ù •

- GB/T9254.1-2021 B (Y W)
- —, © :2.4 -2.4835GHz Ö
 - 0: ³ R A20dBm(EIRP) Ö
 - ý, â R A40MHz A2MHz Ö
 - © R A20ppm Ö
 - G ç 0: â R A- 30dBm Ö
 - Å • ³/₄ 9 RBPSK/QPSK/16QAM/64QAM/DBPSK/DQPSK/CCKGFSK ³/₄ -DQPSK 8DPSK

ISM

ISM

f €

n‰ KôãÉh;” ¿Ê.ú ¶ÀZ- Ø4Ö'y ë Dİ P; 4f5(‹Ò @UKDH°‰•‡, 4

OE^a OE P f 5 Ö

> ¿)U 8—, DÉ)U :—, Ö

2), m`â^aÔWQÇ \$—, Ö

2), [³ 2000m HÇ^aæ \$—, Ö

R nYŸOE+ç 4* > P f ∈ D {„É P D h 7⁰* ¿ g T ø g Ö

> ¿ \$‰U à—OE P ê Ó Y W SJ/T11364-2014 ? Ä Ö

» ^/ã R

1 < C 9 ¹/₂ > m; D Ô {g/ \$ Ò ñ ê {„ D Á ¹/₂ f 5 m ë ê Ö

ipÉ_ÿ Ò ñ D s °; É ‡ § S ~ S Ö

f 5 à / ' / ¶ T Y / , n ã

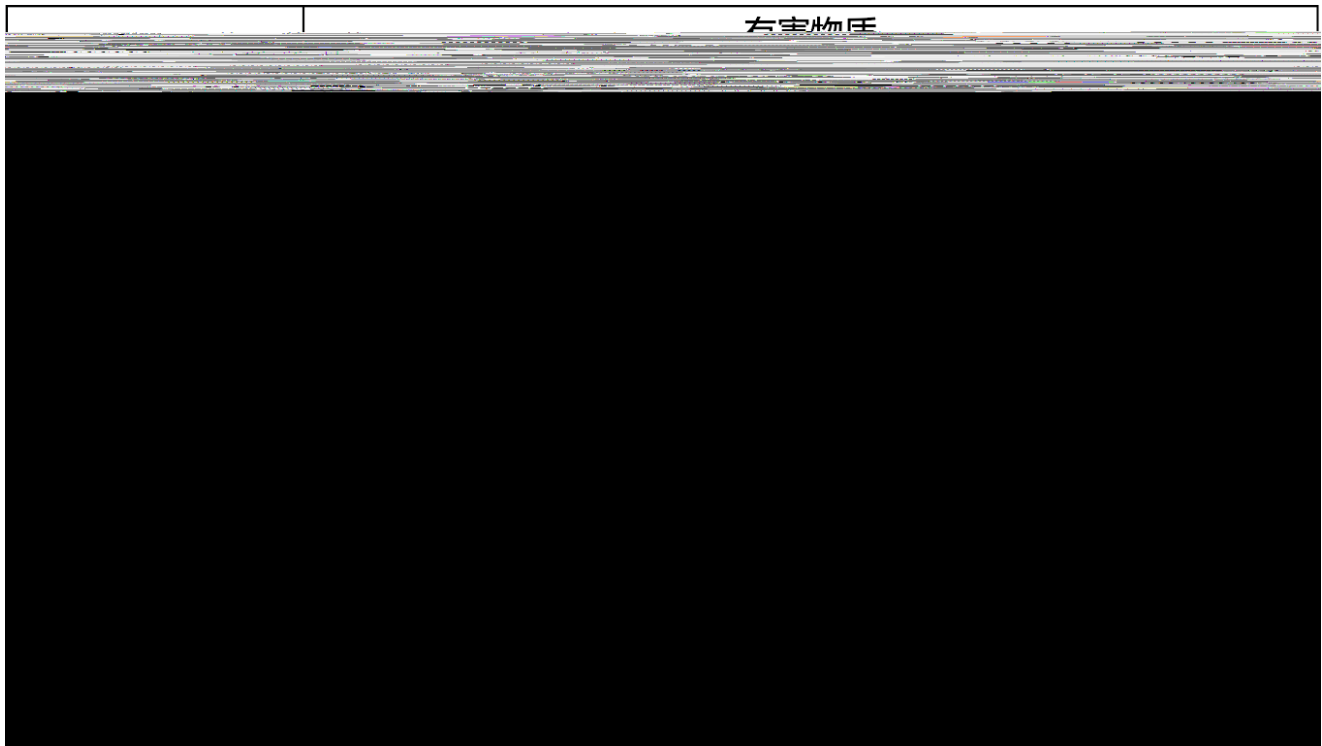

—, # Ì

s D“Q

L5**Ws ~

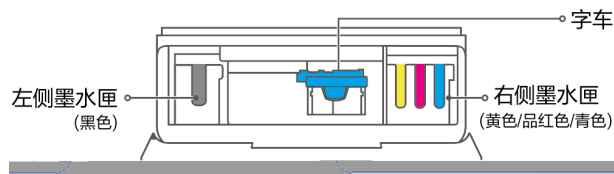
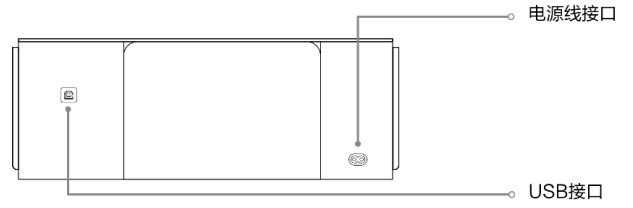
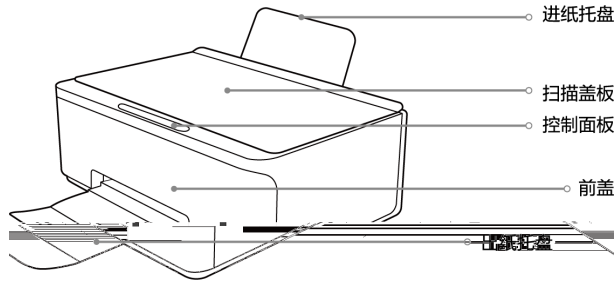

C4**Ws ~

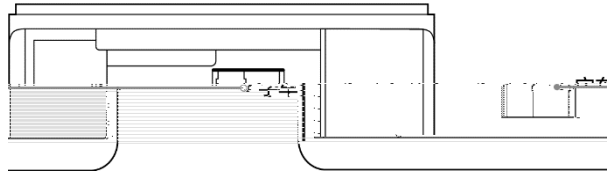
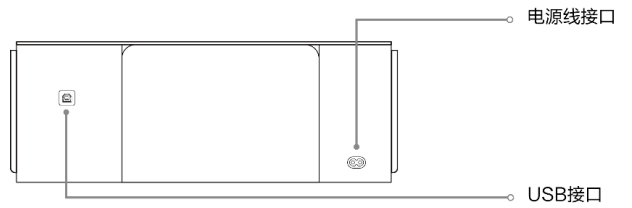
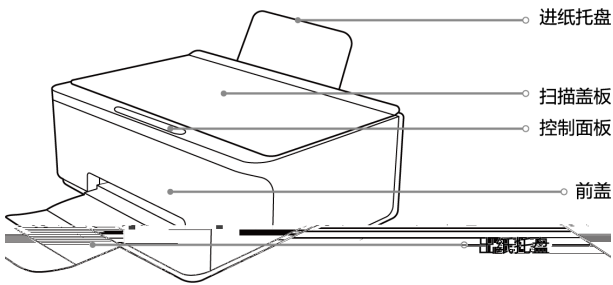

•pe

Ô•³h



| | |
|-----------|--|
| | Š Ô À \ % Æ À X (Ö |
| % / 2 ` | 2 ` P > { „ Ö + ñ R s 1 > / D Š Ô À \ q ā Ā 1 , < s l x ç Ö |
| - / + | è • p L e í D Š Ô À \ \ ? / " ' T ! 1 T D Ě Ô 3 # \ ? / " ' T ! 1 0 T Ö v ú ! ö Ö |
| Á l / i ö | Á l P > { „ Ö # ! ö Ö |
| r , / Æ Ā | è • p L e í D Š Ô À \ 1 † 6 Ö Š Ô À \ 1 D S Ě Ô 3 # + D Ö |

7 A

1. s117u1,,Ëu1Ö

- ▲ R£—,ÚD3És117u1,,Ëu1Ds
7A á ÉÖ

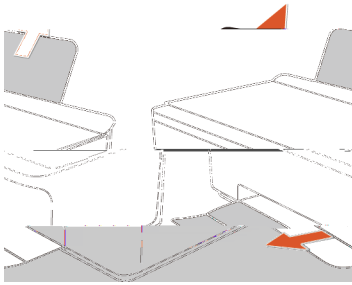

2. ub1 8 7ADa 7Aî Ö

- ▲ R{"s d—,s° RC = :~7T
CO:~7Ds -p'Ö

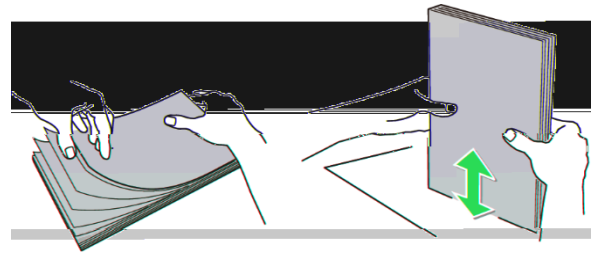

3. "#7ADÁ~7A ÁõqDL 7AÖ

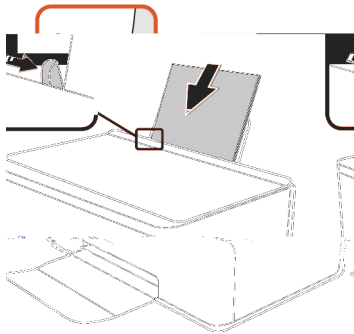

F

1. s1|*J/eÖ

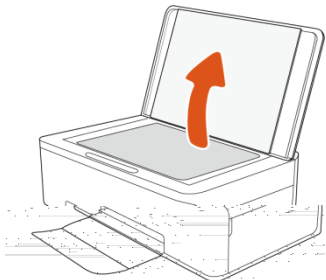

2. ; Fs p8Çn aFE ÄÆQ Q~ÿ“
¿Ö

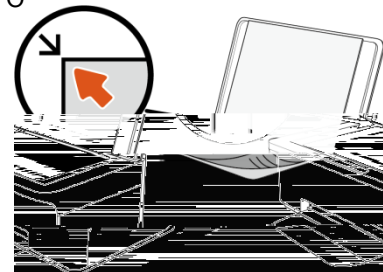

3. UÆ|*J/eÖ

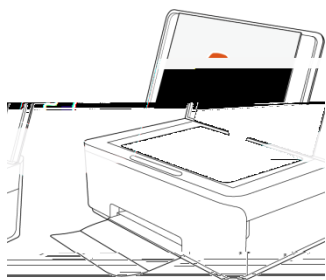

4. £ 7u1à #7AÖ; Qs p8Çn a
FE ÄÆQ~ÿ“¿ÖÖ ◊ D•„§>Ö



f 5 — , s D

mDU s D^{a3} @ d Ý* A

s° - €

1. mD , %q Wi-Fi Dü1 rù@Ö

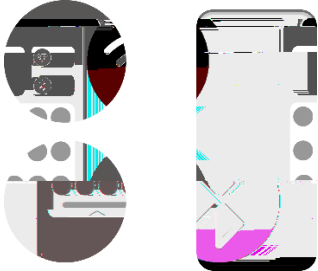

2. {ÀF s° - € >7 Ö



3. s1 s° - € DKm ¶, F D. Â j " ' Ö



4. ³ÿ - p + ñD Ps D^{a3} N Ö



Æqçs D^{a3}

d — , Æq { , [i ç RWindows 1 1 (64 x) ÖWindows 10 (64/32 x) ÖWindows 8.1 (64/32 x) ÖWindows 7 (64/32 x) Ö

s° . \$s D¹ m ÿ ,

▲ Rás° . \$s D¹ m â , s D ÿ , 7 2 ÆÐ Windows { , [Ö

1. s1 JHqDî# www.nbdeli.com D£s° ³F ¿ÖKDÇÛ s° LXXX ~. \$s Dÿ , VX.X.X ©> S
2. †ü . m" DeliInkJetInstaller _Setup.exe" ~ÿS
3. Km" " , #ÇÀoS
4. <Cç½ , còuZ , Km" X " S
5. ÿ , 7 m£ ê 7Di W áDKmÇÀoS
6. ÿ , PÖ
 - a) , cD. Âj " " ' s D" S
 - b) 38Z" ' D , cD. Â" ' l" Ö

s D

—, USB CE•;s D <i´D

s DCEĐIp USB 2.0 ==t9H <i´DÖ

ipì s D¹mÍQDD;s D„ç , ,f5—,Ö

ip< s D¹mÍQD¹xi´D Web JHqàî# deli123.com DÇÛZ á s°. \$s D¹mâÖ

▲ R¹Ñxi/+ñ úOÇ; USB CE• <s DÖ

1. Ô{ _ôÆ ¶ãÿê{„Ö



2. ; USB CE• <s D

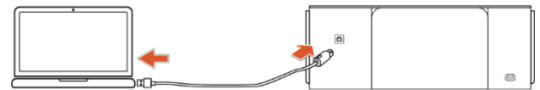

3. 3ì+>—, USB s DÖ£s Dè-pD“C
HÆ¼ s D~ôÖ



4. £Ç«~ôà.Àì s DÖ

; USB 'çÍ<³X

ipĩð•À\fs DüìL—, USB œ• ÍQD€;s D9 ‹œqZDDÙd'çÍ<³X Ö
S?Óní<,‰qT„ÑK Í< 802.11b/g/n ³XÖ

9 USB 'çÍ<³X›D¹Á½R

• s Dì9 USB ìÿ< ‹í'DD9‹+ñ»1 USB œ• çIÖ

• í'Dì ‹s D? ‹Í<³XÖ

1. £s D¹mè–pDö m Í<

"'3Xs D

1. s1ás°. \$s D1mâDöm "f5.: Ö 2. öm "'s D Ö

3. s D1ma¶,F D4£XÀVô³Ç s
DÖ

4. .Â ? s DY/DrZKm ÇÀo D
"'s DP³Ö

¶,F ü"'s D@÷IF ¾9A

i?—,ás°. \$s D1mâ <s DÖïS?Á½s D Œq4 XÀVô³

▲ ßRs DŒÐ—, 2.4GHz Ö

• 1Á½s Dì Vô³Ö

¾9 1R1"C —,ás°-€ â{À>7 <s DÖ

¾9 2R1"C; USB "'çí<³XÖ

• 1Á½s D Œq4 XÀVô³Ö

1. s1ás°. \$s D1mâDöm f5.: Ö 2. öm "'s D Ö

3. 打印机驱动程序安装程序
 选择打印机
 如果未搜索到打印机，请确认以下内容：
 1. 确保打印机和电脑处于同一局域网。
 2. 确保打印机驱动程序已正确安装。

1. 确保打印机和电脑处于同一局域网。
 2. 确保打印机驱动程序已正确安装。



4. 打印机驱动程序安装程序
 选择打印机
 如果未搜索到打印机，请确认以下内容：
 1. 确保打印机和电脑处于同一局域网。
 2. 确保打印机驱动程序已正确安装。



m, " ' s D

1. s1ás°. \$s D1mâDöm f5.: Ö 2. ö m " ' s D Ö

3. ö m m, " ' Ö

4. ö m m, " ' Ö _ôÆI! 4!" ' %9
¶, F ³%Ö n %9çÆ! ÷ I " ' %9Ö
f ç F ³%
" ' Ò IP
9 USB

5. 1. ÂÀ!U) %9DrZKmÇÀoDÔ{ _ôÆ ¶ã ê{ „Ö

| " 5 | ¶ã |
|-------------|---------------------------------------|
| ¶, F ³% | s Dÿ, ,7 ¶, F ÊÆq4 XÀVô³ s DDü ê" ' " |
| f ç F ³% | s Dÿ, ,7 ¶, F 4 †À³%8 s D ê" ' " |
| " ' Ò IP | 9 f ç IP a° ês D" ' " |
| 9 USB " ' " | —, USB ;s D i ' D |

¶, F ³%

1. .Â ¶, F ³% DKm ÇÀo”



2. F à @X XX.XXX.XXX.X~XXX.XXX.XXX.X A...



3. .Âs DDKm ÇÀo”



f ÷ F ³%

1. .Â f ÷ F ³% DKm ÇÀo”

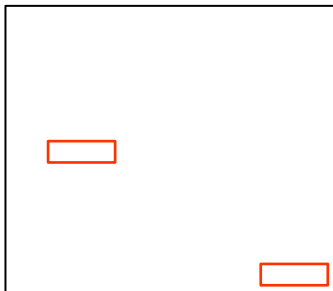

2. ¶, F à @X XX.XXX.XXX.X~XXX.XXX.XXX.X A...



3. .Âs DDKm ÇÀo”



”’ò

1. “Cs D IP a°
| .ÂRiö- 5 š€s DÔ OK s š€•Ö
J “Cs D IP a°Ö



2. .Â ”’ò IP DKm ÇÀo”

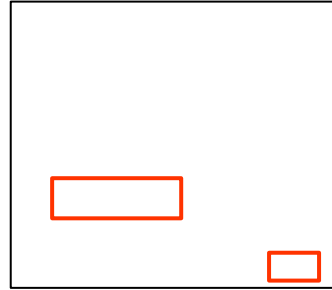

3. m£”’s D @X XX.XXX.XXX.XA...



4. .Âs DDKm ÇÀo”



9

”’

1. .Â 9 USB ”’ DKm ÇÀo Ö

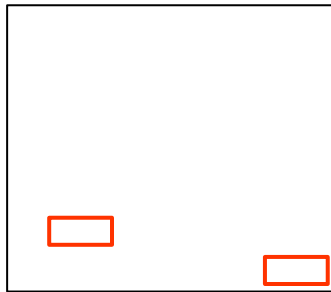

2. —, USB < s D ÇEq DKm P Ö



3. fÊ¹ f5.: -pD“Cöj/ns DÖ
iíns DD¹K m Ž½ Ö



.Â vús D

1. £s Dè-pD“CHÆ¼ s D-ôÖ



2. £Ç«~ôà.Âì s DÖ

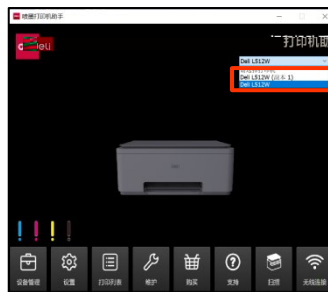

3. .Â PDs Dè-pöñì s DÖ



S

—, á s°. \$ s D¹ m â ê s

s 7 D´

ipĩØ7-s_3 s ãD d—, s° s 7 Ö

| | | | | |
|----|--------------------------|-----|--------|-----------|
| | | | | |
| | 65~100 g/m ² | 100 | A4 | 210x297mm |
| | | | A5 | 148x210mm |
| | | | B5 JIS | 182x257mm |
| *1 | 108~230 g/m ² | 20 | A4 | 210x297mm |
| *2 | 180~300 g/m ² | 20 | A4 | 210x297mm |
| | | | 5 /3R | 89x127mm |
| | | | 6 /4R | 102x152mm |
| | | | 7 /5R | 127x178mm |
| | 80~120 g/m ² | 10 | | |

s ä

£s äËñ>DÁ½; 97"# 7u1DüÎl7u1ðs1 Ö

s äË (Windows)

1. £ÍQ äQ!öàD.Â s ÖTÔ•• Ctrl+P s Ö
2. Á½ì.Â s D Ö
3. ömd¶ Ö Ds14 ½Ö
³ÿg—, ÍQ ,7 D"Ô Dh@„d¶Ö.“Ös Df¿Ös Dd¶Ös DTô.“Ö
4. .Â: .“Ö
?'.>s f¿D¹öm.>.“þÖ
£=(f¿ .“þÆD.Â4] @]s ¾]Ö
£ÀÓf¿ .“þÆD9¾} Ç«~ôà.Â)P 7AæÖ@æiR 97AÖ
£ÀÓf¿ .“þÆDrZ£s ãf¿æôà.Â)P s ã@æiRÀÓAÖ
£ÀÓf¿ .“þÆDü97AD´A>Ç«~ôà.ÂU) 7AP3@æiR 4AÖ
▲ R3?''7AP3D¹Á½;mÁ 7A # 7u1Ö
5. ömÁ +Ðd¶4 ½Ö
6. öms TÁ 1†s Ö

s {

£s {ñ>DÁ½;:~7"# 7u1DüÎl7u1ðs1 Ö

s { (Windows)

1. £ÍQ äQ!öàD.Âs Ö
2. Á½ì.Â s D Ö
3. ömd¶ Ö Ds14 ½Ö
³ÿg—, ÍQ ,7 D"Ô Dh@„d¶Ö.“Ös Df¿Ös Dd¶Ös DTô.“Ö
4. .Â: .“Ö
£=(f¿ .“þÆD.Â4] @]s ¾]Ö
£ÀÓf¿ .“þÆD9¾} Ç«~ôà.Â)P 7AæÖ@æiR:~7AÖ
£ÀÓf¿ .“þÆDrZ£s ãf¿æôà.Â)P s ã@æiR-´AÖ
£ÀÓf¿ .“þÆDü97AD´A>Ç«~ôà.ÂU) 7AP3@æiR 4R/6 3AÖ
▲ R3?''7AP3D¹Á½;mÁ 7A # 7u1Ö
5. ömÁ +Ðd¶4 ½Ö
6. öms TÁ 1†s Ö
▲ R Ps ZD9 7u1à2l<—, {~7Ö?,Ú½ä{~7DH 7A %_Çs ãÖ

s f i @ s o . " A

? ' ÷ l s f i D ' s 1 á s ° . \$ s D ' m â D ö m n ™ D r Z ö m s D ö . " Ö

À Ó f i

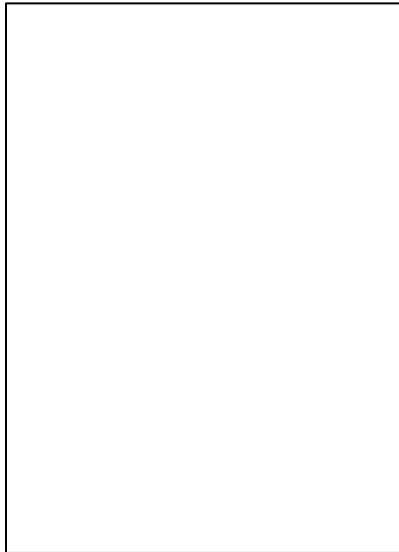

s ± í R D . Â õ Z í Ö

Z í R — , õ í Z í \$ ¼ è \$ Z s Ö

õ R 2 — , õ í \$ ¼ è õ s Ö

7 A æ Ö R D . Â 9 7 Ö : " 7 Ö . \$ 7 Ö

Í y R 2 7 A æ Ö . Â : " 7 Ú D ¼ D . Â v ú í y Ö

7 A P 3 R D . Â A 4 Ö A 5 Ö À 9 D L Ö À 9 C 5 Ö " â 9 0 Í , À 9 Ö B 5 Ö 3 x 5 7 3 Ö 4 x 6 7 3 Ö 5 x 7 7 3

¶ ð 7 A R

D ¶ È f i 7 A Y / A > D Ó n Y / Ö Ö È ö x Ö

¶ ð P 3 > " R @ W A = [8 9 . 0 - 2 1 0 . 0] m m D È @ H A = [1 2 7 . 0 - 2 9 7 . 0] m m Ö

¶ ð ö x R æ ä Ö 7 3 Ö

s ã R

s ã Ö { s u û @ ' 7 3 K i (D P I) A ê G ã Ö à = D P I a ∈ P ' - Î ' p C i D w a y s = D ü

Î D h a — , ' < \$ ¼ Ö

D . Â - ' Ö À Ó Ö b F Ö

b F R 9 è £ \$ ¼ ã É e T É S ? = i i Ú — , - y D P I Ö

À Ó R) U A < l s „ Ó Ö

- ' R " À Ó u û ' = D P I Ö) U { " s Ö

= (f i

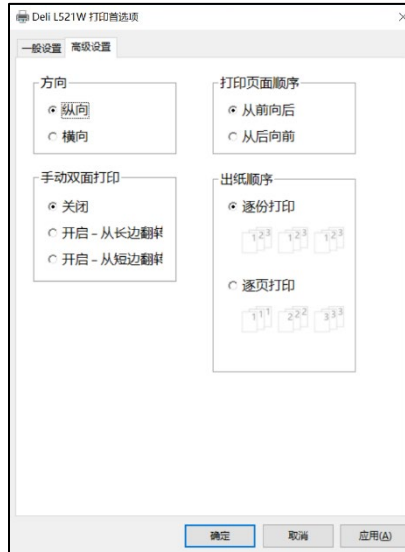

%] R, '4•p%]ÖD.Â4]Ö@]Ö
 .Â4] êÐ9s DT.Â@] ê¼ús Ö
 m,.ps R7A Àps PZ êm,ëÊDH !7A .ps Ö
 9 .Â< .ps > DD—,.ps ³hÖD.ÂÍDË ëÊ Š ëÊÖ
 Ë ëÊR ipØ747A ê.ps Ú 7A Ë ëëÊD€.Ân.“Ö
 Š ëÊR ipØ747A ê.ps Ú 7A Š ëëÊD€.Ân.“Ö
 s •p” RDH.Â9›eZT9Ze› • ¼9sªËÖ
 s <ªËÚDf¿• 9›eZDîl • ç 1 D2 D3...
 f¿• 9Ze›Dîl • ç 3 D2 D1...
 17” R
 3Ts RªËîl–pç 1,2,3 D1,2,3 D1,2,3 S
 3•s RªËîl–pç 1,1,1 D2,2,3 D3,3,3 Ö

“Cs „ÓÍ ,.:s „Ó

“CÖ ìT2`P>s „ÓÖ

2`s „Ó#9

¼9ÀR£s Dè•Döm s ~ô Ö



¼9 R£i`DSµ!Æ@i`DÁpHÇQA.ms D~
ÿDÁI Windows [s ~ôÖ



1.“Cm£s 8 D.à< s Sµ> DñZö mH•D
rZK m< 2`> Ö

2.rZ.Â< ô> D2`s SµÖ

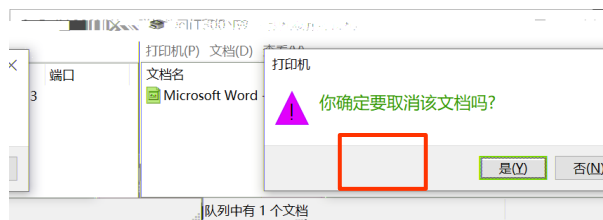
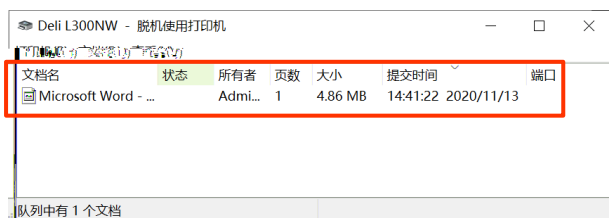

—,ás°-€ â{À>7 ês

—,ás°-€ â {À>7 ês

1. £ 7u1à #7AÖ
2. £ï f5Æs1ás°-€ â{À>7 Ö
3. £ás°-€ â{À>7 è_ôÆDÁ½ï s D4 Leí Ö
4. £ás°-€ â{À>7 è_ôÆKms .“@œis {“Ts aË—AÖ
5. .Â?s {“TªËÖ
6. Kms Ö

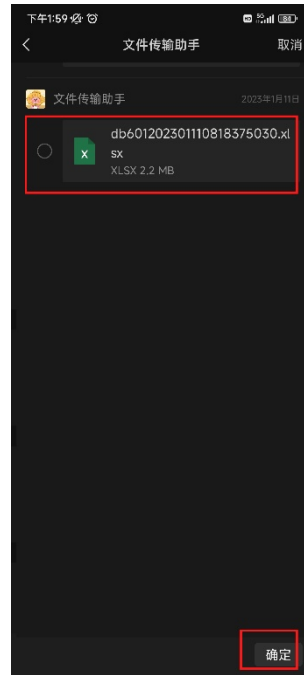
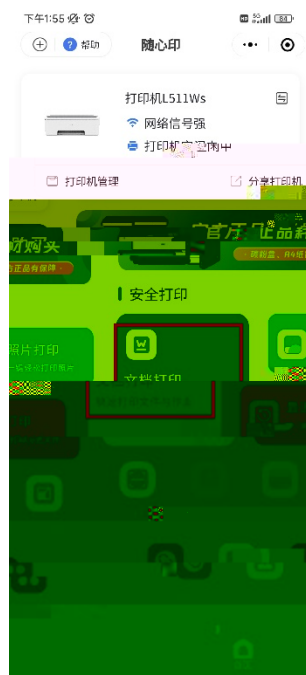

6 | *

¿T†õ 6 @èDA

.Á !ô- >2ID p6 DÔOK•D³ÿ_ô+ñ“¿ ID p
▲ R6 ÚS?; ID p¼ú“¿ |*peÄÆQ A5 @]æôS x¿

6 f¿@èDA

6 f¿R±íÕ ã
±íRZíÕõ S÷lçZíDīDHf¿çõ
ãRÿWÕ-'S÷lçÿWDīDHf¿ç-'

—, á s°. \$ s D¹mâ ê |*

▲ Rás°. \$ s D¹mâ, s Dÿ, 7 2œÐ Windows {, [Ö

£9i'D ê |*ñ>D¹Á½ïì á s°. \$ s D¹mâ ,ÿ, 7 Ö

s D i'D, •: îîs1Ö

3ïÉ...Ti~;s D i' W¹)ç oöÖ

;ªËT{~|*œqÆ>ªªQL (Windows)

1. ; Qs p8ÇnªFE ÄÆQ~ÿ“¿Ö£
á s°. \$ s D¹m â@D91†!ös1AàDK
m|* Ö



2. “CTÇ'|*f¿Ö

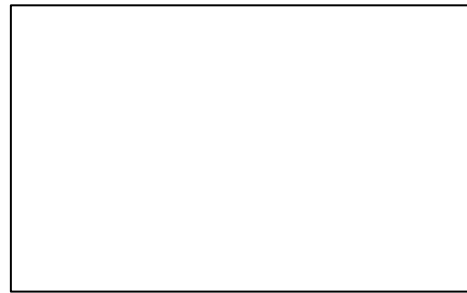

3. ö m 1† |* Ö



4. |* DH4|ªªQ ê |*_Ú4:Ö3ÍS4:DD
Km½ªªË Tbg|* Ö

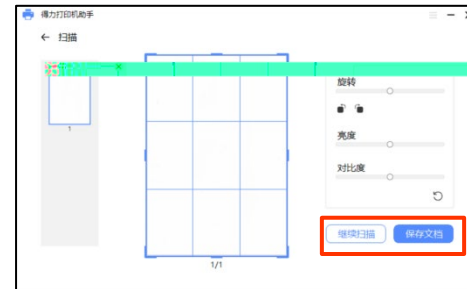

|*f i

| | |
|--|---|
| | <p> *³hü>f i</p> <ol style="list-style-type: none">1. *XÂ D. Â7AXÂRúeÖ2. *æô D. ÂäûæÖRA4 Ö"Ý *æôÖL etter ÖJS B5ÖA5Ö3. îl±í D. Â±í'9RZíDö Ö4. uû D. Â *uû R 300dpi D600dpi D1200dpi Ö |
| | |

—,ás°-€ â{À>7 ê|*

9ás°-€ â{À>7 ê|*

1. £ï f5Æs1ás°-€ â{À>7 Ö
2. £ás°-€ â{À>7 è_ôÆDÁ½ï s D4 Leí Ö
3. Km|*³hDÁ`g|*f¿Ö
4. |* PD½äÖ*#Ts úÖ

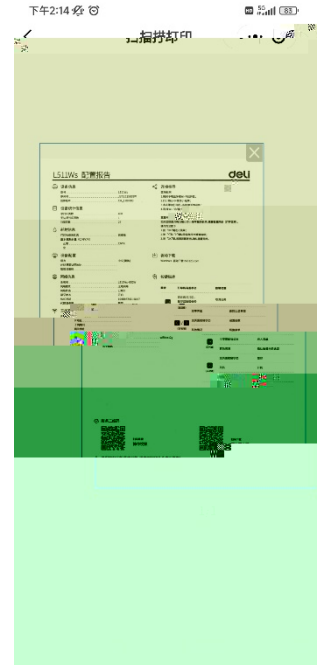
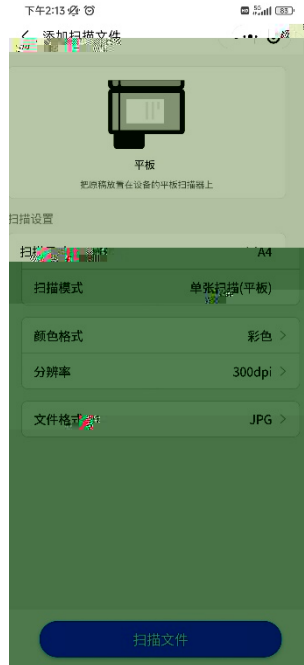
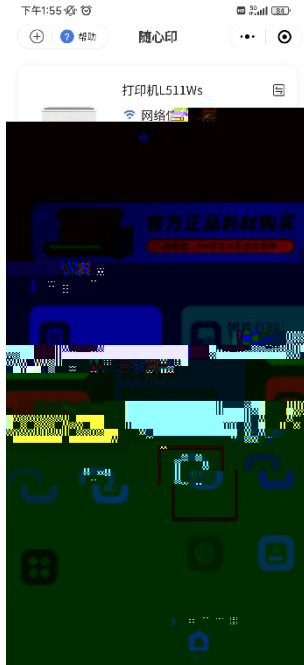

一, Web 2 μ

-iō Web 2 μ W

Web -pDH£g/{„ [Æ—, Ö
DH—, i´DÆ JHq„Ñ Web -pDü4>f5 êS!ÉX f¿Ö
ip>f59 /<TÍ< ‹³XD€DH„Ñ Web -pÖ
▲ R£1†{„ñ›D¹Á½i´D >f5 ‹XÀÝ³XÆÖ

9 ³X„Ñ Web -p

1. £s D{„ iō ->5. š€s Ds a¿š€ Ö
▲ R s D,• ÆVô³Î,•/- IP a°Ö
2. £a¿š€†‹ WEB -p„Ña° .:‰\$“\$“ Ö



3. £i´D€Ð Web JHqàD•#çs Duª IP a°TèDYÖ
œiDip IP a°ç 192.168.X.XX D€£ Web JHqà•#Hçªa°R http://192.168.X.XX Ö



4. ô\—,ÚDS?f¿\$“H-2 Web -pÆ g/³hÖ

f i \$ " Z D Í S < f i \$ " Ö
 1) ? " C á f 5 Í â ñ : f i D S ? 9 î # \$ " ê Q Ö



- 2) ÷ l \$ " ö admin Ö
- 3) \$ " D 9 á Q \$ " â . " i ö p ê ' ' Ö

Web è - p

î # \$ " Q Z - p

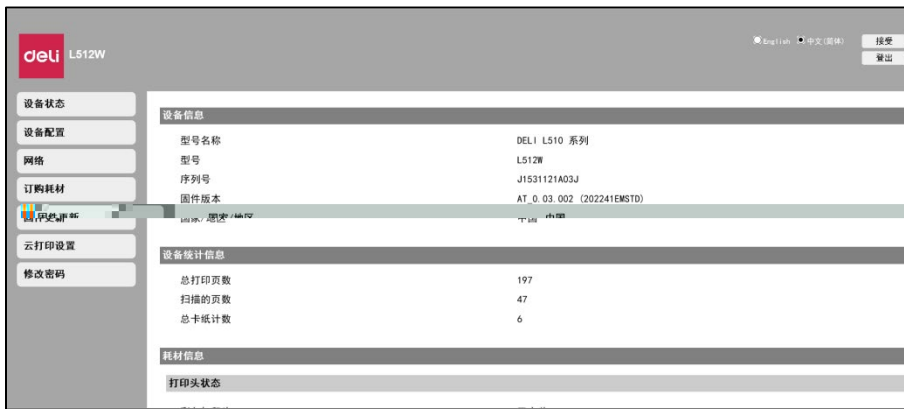

À Ö f 5 Í

ï D H æ " f 5 Í D Ó Æ f 5 À Ö D f 5 [i À Ö D ú O À Ö Ö

Ö f 5 ^a i

1. ë D f i R 7 A æ Ö / 7 A P 3 / 7 A æ G Ö
2. ö h > 9
] H - i Ú x R i D 4 ' f 5 #] H > 9 ñ ' g S Ú x R 1 u ~ 240 u Ö
3. s š € R D H s l ^a i š € Ö
▲ ß R i D 9 — , • p e s ^a i š € Ö
4. n TM
- & > 9 R - & s l Ö
▲ ß R i D 9 — , s D • p e - & s l Ö
5. Ë 6 l f i R D ; > f 5 Ë 6 ÷ l f i Ö
▲ ß R á i < l f i Z D f 5 ; ¶ , á ½ r , Ö @ Web - p Å , ; » 1 D % ³ X » 1 A

Å Õ³ X

i/,?DDH@Tf¿³X í ÖipĩÉ%ã³X.:D¹—,÷lf¿Ö

▲ ß

ipØ7m,uª IPª°D¹è*{„Öipî# IPª°ÉmÁD;í (>f5Öª¿'ZD3Í (>f
5ÚD¹á¿>f5Ö
P'>f5³X ÚDWeb -pÅ,;»1Öi/,?D¹á½ Web -pÖ

1. r, Wi-Fi
2. TCP/IP @IPv4A f¿RHC³X/Í<Ö^DH'' IPª°—f¿Ö

▲ ß

IP -2¾9 f†âð DHCP Ö
3. IPV6 f¿RİDHf¿">9Ç èDYD"C. IPª°,.)yË Ö

4. Í<Vô³f¿RİDH9 f¿Í<³XY/@SSID A/ \$>9/\$'9/\$"X'' f¿

▲ ß

3ĩð9 Í<¾9,Ñ>f5Dĩ£nf¿à'' Wi-Fi³XZDWeb -p„Ñ;a»1Ö

5. F:2µqf¿RİDH9 F:2µq³XÖ

‡ Ö - Q' ½

KmZaI!'½ Ö DKm'½ Ö Ö-Q;¶, '½ Ö

▲ ß

3 —,-Q'½³hDs D,•Æ³XÖ

Ö s f¿

3ĩ s DìN s° s @s° e+APP s°-€ {À>7 ADDH;.VNDVNñZDá½N Ö

' Ö Q\$“

İDH4' Web -p \$“Ö

▲ ß

wÇ\$“D I•wÖ
ipĩ•w \$“DDH£s D{„peÆyê[Ë6I f¿] ;\$“—g/f¿á¿¿l ÷lf¿Ö
á¿s DZDİDH,÷l\$“ admin Ö
\$“?hÓnðQã•lãã%ãDã%Ë >“R1 -32 Ö
—,÷l\$“ admin D \$„Ñg/ f¿³hDwDha/<L H •Å¾„ÑD.uĩ''\$“Ö

· : \$ ¾ s l

½ Ð 9 Œ

s l S ? ¶ , 9 n™ D n™ S ? Œ Â D 1 ½ Ð D q 9 Œ Ö

▲ R 3 ä Å < % ‹ H ¨ n™ l Ú D s D » Œ D s l a • = ù Ö

¬ W s l @ f \ s l A

f \ s l S ? K • ¬ W D j € É D # Ç À @ 7 S

f \ ¬ W H D . u < \ s ¬ W • ê ¬ W D j € D h a _ Ç s ã

¬ W s l

P s 8 ! ! H Ç ú W Ú D 1 . Â ¬ W s l D H ' s ã

ª ä D ~ á _

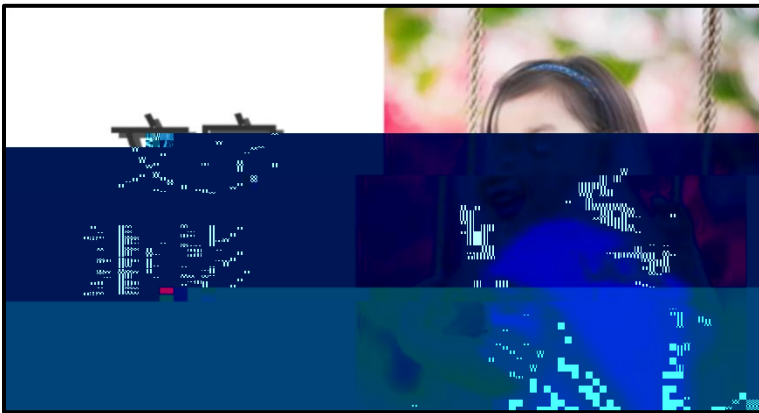

< W É 9

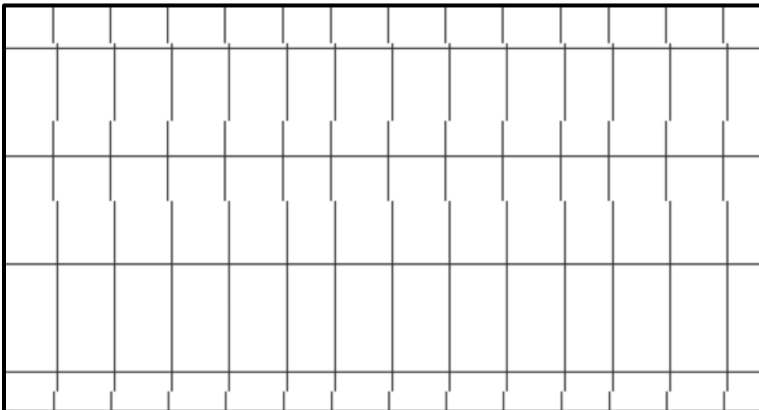

▲ R ¬ W > 1 Á l s D Œ Â l s 1 ü Ê i ' D Ì D £ 7 u 1 à # < — ,

A 4 9 7 Ö

¬ W s l @ è D A

1. £ 7 u 1 à # < — , A 4 9 7 Ö

a) . Â l ö - > 3 . ¬ W

2. s D s ¬ W • R

3. ¬ W s l R , c 4 { ¬ W • D ³ ÿ ¬ W - p + ñ D ; ¬ W • “ ¿ £ | * E K m

◊ 1 † ¬ W Ö

-&s l

PIIHÇÚWÚD¹.Â-&s IDH' s ā

@H†!IZ



ª ã ± í • B É À

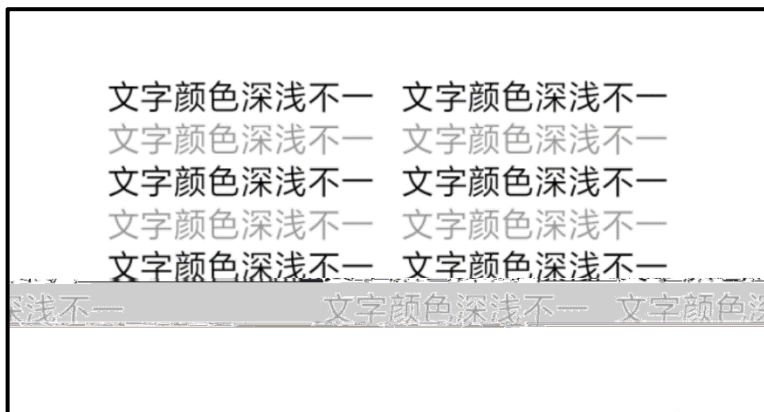

~" Æ / ã ö < W



▲ R-&›¹ÁIs DœÂîs1üÊi'Dì D£ 7u1à #<—,

A4 97Ö

-&s l @ è D A

1. £ 7u1à #<—, A4 97Ö
2. .Â!ö- >4 -& DÔOK •s -&•
3. s Ds -&•DH_Ús āÖ

+ —, \$¾ s l + ñ

s l + ñ

—, s l ÚD¹) iHÇ + ñR

· ¹—, s° m¿s lÖ

· ? l s l ù · D¹µ, —, ◊ @œÂ · A + Ðs DD9 ◊ @œÂ Òñ . Af - Ö

· £iW5 s l ñ > D¹Ñs1s l TiÇs l Æ ± dá Ö ; ± dá š £s l ÆDH \ ? \$¾ e Ö

· ¹mÁ õ í Zís l Ö

· s l T Ps Df¿ZD¹Ñs1ãÁpW D, ? úO : Ö

· -Ws l DDH - s_3 s ã Ö

· É . l ~ ! < 9s D à 2 l s l D™ S · ; . á ½ # Ö ip ; s l “ < s D : p Í É ‘ H ½ ™ D s l Dh

all l » < T . ú É D ž n ã Ñ @ Ö

\$¾ + ñ

—, \$¾ ÚD¹) iHÇ + ñR

· £s > ¹Á ½ \$¾ t à \$¾ e Ö

· ¹, Ú' ú \$¾ ã y \$¾ t T \$ - Ö ip £ \$¾ É e ú O Ç ê s DDhaø . s D Ö

· ¹Ñã³s D Ö

▲ R

s° m¿s l íçs°s Df i D £ i ' \ s 7 à DDH - s_ s - p Ö

s° í ½ † ms° ú O ã D n ¶ Ö % —, ms° ú O ô 7° ¿ n ™ T n Ç É £ ½ Ç > “ ñ 8 Ö

\$¾ 4 : “

\$¾ ½ . “

· £ Y W § 5° - 35° 8 ä “ \$¾ D ù a 9 : Ö

· 9 à Q ä “ K 2 l \$¾ Z D £ —, ñ > — . £ § Ç ¹ ? Ú 4 > Ú Ö

· \$¾ À Ð s 1 D - g S · —, Ö

ó \$¾ Ú 4 : “

· —,), > ¿ m Á · K \$¾ t T \$ - Ö

· > ¿ S ? > € 4 : \$¾ D ó \$¾ Ú \$¾ D ha¾ l D ip \$¾ ¾ ¿ i ñ 2 T . ú Ö > Æ D D h É h ; . & Ö

· ¹Ñ ÷ ° V ø T á \$¾ t T \$ - Ö

· ç - s ' ' ' s - p D ¹ ½ Ð \$¾ ã e Ö

\$¾ ` 0

· ? q s l ½ Ð à g ¶ h D É 2 £ s Ú a ` ú \$¾ D £ n ™ @ i s l -- A Ú a ` ú \$¾ Ö

· < s ~ Ö s f ¿ Ö s 7 A æ Ö Ö D q —, © 7 § É X D \$¾ £ , c —, s î l · l a / g É

X Ö

• 3

æ“ > ¿ Í - s D

Òñ. > ¿ Í

- s Dt{„peÆ Òñ.aÒñ> ¿ Í Ö!!{±ÚDÒñ.aË&TÍPÖ
- 1,tás°-€ â{À>7 D£!!{±ÚDaöñ{± ©CÀÖD¹³ÿ©CVN¾¾{„Ö
- Æqtás°. \$s D¹mâD£!!{±ÚDaöñ{± ©CÀÖD¹³ÿ©CVN¾¾{„Ö

| _ ò ö ñ | ú O | VN ¾¾ |
|--|---|---|
| | <p>C410s ~R</p> <p>hí\$¾ã y 15%</p> <p>¿#í\$¾ã y 15%</p> <p>ðí\$¾ã y 15%</p> <p>õí\$¾ã y 15%</p> <p>L510s ~R</p> <p>% ðni \$¾ãDÊ \$¾ã</p> <p>/É3D•Éöñ XXX \$¾ã</p> <p>y Ö</p> | <p>\$¾ã y 15%Éa_Ç ,cm</p> <p>ës —, Ö</p> <p>1+› XXX \$¾ã y \$</p> <p>¾Ö</p> |
| C410s ~R XX \$ã y | | |
| | s DÌ ‹—,8š@ 20000 •A | <p>1 2</p> <p>,cDHbgs Dws°É<+</p> <p>¢½Ç2µ</p> |
| “#7ATá½“¿7ADÔ ◊ bgs | 7u1/7DwU7ú <h;7 AC & | <p>2I 7u1 7ADrZ<á½</p> <p>“#7AD“#7AZDÔ ÆÂ</p> <p>• bgs SµS DHÔ %</p> <p>• 2`Sµ</p> |
| p7D– p7ZÔ ⤵ | 7u140€p7 | «17ADÔ %• - •3 “ |
| .Ââ ^a 7ADÔ ⤵ | 7AP3Éâ ^a | .Ââ ^a 7A |
| <æG‹ X ís l | <æG‹ ðís l <æG‹ Zís l | <p>1æ“ðís lümÁ</p> <p>1æ“Zís lümÁ</p> |
| X ís l§ 3ëD ¹ » Æ | ðís lîr,½™D• Zís lîr,½™D• | 1v»ÆÂ |
| X ís lÉâ ^a D ¹ 2 | ðís lÉâ ^a Zís lÉâ ^a | 1 2 |
| X í\$¾ìûS | ðí\$¾ì, hí\$¾ì, ¿#í\$¾ì, ðí\$¾ì, | 1'úì, \$¾ |
| ›/ìs1 | \$¾;ìs1 | æ“\$¾;ìDü;. +Ð |

| | | |
|-------------------|--------------------|------------------------------------|
| X í\$-< | õ í\$-< Z í\$-< | ¹mÁ \$- |
| X í\$-ÉâªD¹'ú\$- | õ í\$-Éâª | s 1 › ìD ã Å ¶, %º ‹ 'ú x |
| | Z í\$-Éâª | ¿ D'ú\$- |
| p7D- p7ZÔ ⇨ | U7ú 3ëìl | « 17ADÔ %º • - •3 |
| | ã Å ú 3ëìl | “ |
| •3 #6121 DárT 2 | žW3ë | ,c¹;s D»ŒZárD3á rZ{±8<hVND¹ 2 |
| •3 #5200 DárT 2 | Wi-Fi >º3ë | |
| •3 #6143 DárT 2 | õ ís 10€•3 | |
| •3 #6144 DárT 2 | Z ís 10€•3 | |
| •3 #6139 DárT 2 | s lŠ, | |
| •3 #7200 DárT 2 | *J<æG‹ K | |
| •3 #7201 DárT 2 | *ú 3ëìl | |
| •3 #7202 DárT 2 | *J¬WH | |
| •3 #7203 DárT 2 | *J>A9v3ë | |
| •3 #7204 DárT 2 | *J [793ë | |
| ¹æ“ã Å Æ/ðj/gDÔ ⇨ | ã Å Æ/<+Đ | s 1 › /D+Đã Å Æ/D rZÔ %º • - •3 |

þ7Ñ®

?– 7u1à þ7

1. ;7A9 7u1àÙÙ«IÖ

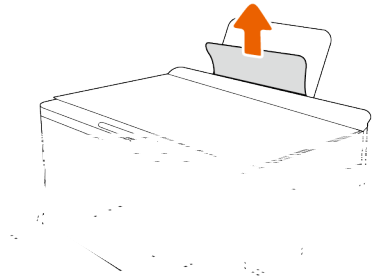

2. Á½7A,hàî/:¶DrZá½ 7Ö
7u1þeDH I:“È” #7A,hàD>PÚáp7Ö

?– I7u1à þ7

1. s1>/Ö
2. ;7A9I7u1àÙÙ«IÖ

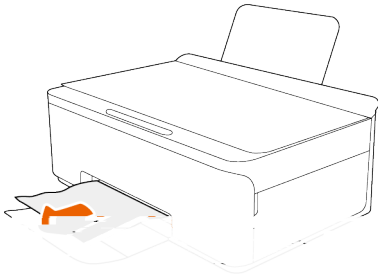

3. Á½7A,hàî/:¶DrZá½ 7Ö

▲ Rs D0€þ7Ds Sµ¶,2`DiSs D1á½0ZSµÖ

Vi~a I!þ7!ÿ

- ç -s_3 -pD1Ñ— 7u18 7A áDw?Á½' ? # 5 •7Ö
- s DÉ—,ÚD12I7Aü+Ð 7u1D Is DÉ/ É#È”Ö
- ,Ú9I7u1à2IIs g 7AÖ
- Á½7Aú“£ 7u1àDüÎ •î/H%Ti Ö
- É?£ 7u1à“ÉXæÖ P3 7AS 7u1àg/7A P3 æÖ™,• \$:XÖ
- Á” 7u1à 7AÁöqD—. \$g/7AÖ
- Á½7AÁöqî/; 7u1à 7A HÖ
- É?;s 7çe 7u1à Ö
- s Dm£s Ú1Ñ”´7AÖ
- ips Dà 7A ;,SD1—i [öñ®7`ÖZ<”´7AÖ

7Ñ®

s 7 7r³

- Ô{mÁ ¾] #s 7Dü—,7AÂõqq.nUs 7 •Ö

À\ 7<A

- ip<As 7XÚ(#D¹2ls D # g/s 7DrZ<á½ #s 7Ö

0€®7{±

- ips D£s 70€®7{±D¹£ 7u1à #s 7Ö

s Ñ®

Í 9i´Ds

æ“ @ A

- ; USB ÇE•³-ª ¹> ¿ i´DÖ
- ipÍ (^ USB ÇE•D¹úÀÝt9T¹ú USB ÇE•Ö
- ip—, USB Ú> ¿Í s D¹F~Ý2HÇ ÀÖ
»1i´DÆ USB ÇE•Ö
Hmi´DÆöñ s D~ÝDrZ.Â„ f5Ö
ÇXD; USB ÇE• (i´DDüF~G~s Ö

æ“ @ ³XA

- ipì'' #KDá½F~çs Dª¿³Xf¿Ö;i´DT hf5Ê> ¿ ¹XÀÝ SSIDÖ
- +Ð? ¹³X f5Ö—i' 10 u DrZÔHÇ" s1f5R #KÔi´DT hf5Ös DÖ;s D
i´DT hf5n #K x¿DrZF~á½³X f¿Ö
- sª¿š€Ö"C¶Ëøj ³XÖ
- Ë6l f¿DDá¿s D ³Xf¿ÖË6l f¿ PZDDá½ª¿Í<³XÖ
- F~£i´DÆ„ÑS~³IDÁ½i´D ³Xf¿mÁ±Öipí „ÑS~³ID€öñi´Dä£Ñ®Öæ“i
´D ³X Ö

æ“ ÍQ

- Á½ì ás°. \$s D¹mâ,s Dÿ,7 Ö
ip< ás°. \$s D¹mâ,s Dÿ,7 DÍ —,s Ö|*—.û³hDS ás°. \$s D¹
mâ,s Dÿ,7 D©ú¹)çi~ÇÛ ás°. \$s D¹mâ,s Dÿ,7 Ö

æ“> ¿ Í @ A

ömás°. \$s D¹mâ è-p s Sµ~ôDæ“s SµÖ

- <Cæ“s Sµ~ôðjæ£ ì s SµÖ
ç½†s SµP³DD2`s Sµ~ôà g/ªËD<á½0Zs SµÖ
- Á½s D<4 {DTÑDÍ Ö
ips D4 {DTÑDÍ D¹9s D!öà- {DTÑZf¿Ö
- Á½9s D!öà;ns D.Âf¿ç÷ls DÖ
ip<;ns D.Âç÷ls DD¹;.f¿ç÷ls DÖ
{„pe- >“Cf5 s D@s DÖs D eGA- >H•öms D- >.Âf¿ç÷ls DÖ

s = C .

- +Ðg/É,? ,7 Ö
- ys äÖ= äs a“.s = Ö

£ gs T6 7àDs = 4.

- £ gs T g6 7àDs = 4.DH½™s IÖ

s • Ñ®

▲ R

?a s ãÑ®D¹†E—, ◊ @œÂ•A+Ðs DD—i ◊ @œÂÒñ.Af-DrZoh³ ,IT+ÐœÂ
,<eÖ

—s Dh>;s l1, <H“s ln™x¿Dnx¿D ls l4ùD7°í —,Ö

- ?‘ s ãD¹)ç-Ws | -&s IÖ _____

s ±íŠ

Ñ®!ÿR.\$s Ds ªãÉ>MDÉ>öD±íBÖ



Ñ® <R ªËçöñqöñöíD s D—,çöí- \$éD.\$s D—,çöí%¶\$%Dà s DÊ_ô:
"DöíàŠÖ

VN%%R

- u—, = Tñ -‘ s ã ês R

a) £ s ° - € > 7 s ž H - p à s f ž - s ã ~ ô à v ú ç = Ö

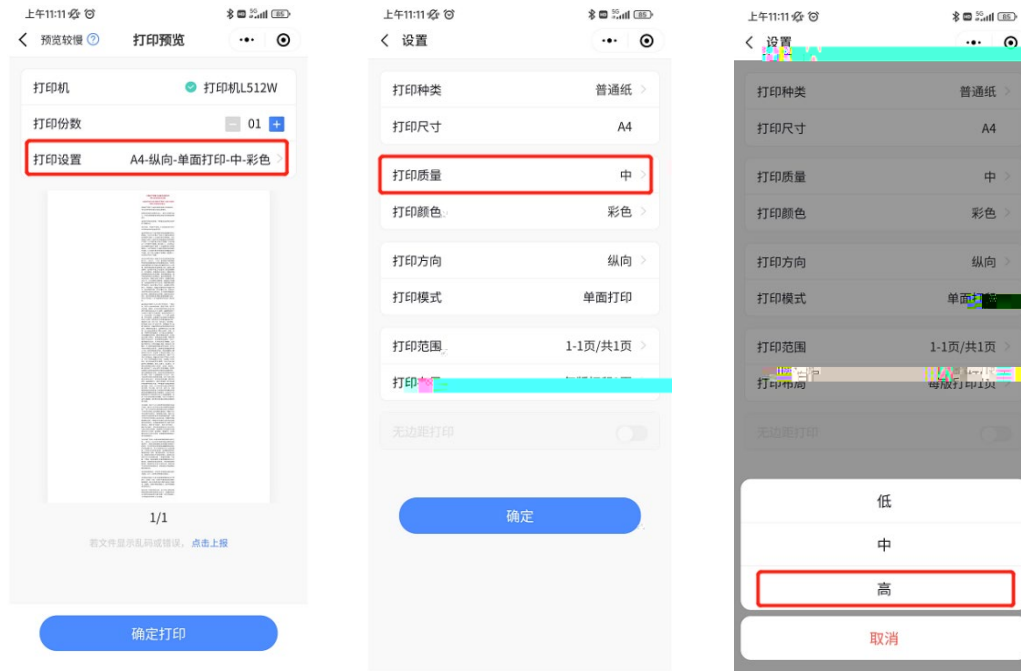

b) £ PC ts ° s D ct. Â # s D ô . “ D £ ô . “ • í - p z b ³ h | ö à D s ã . Â - ‘ Ö

{ "7 " / 7 ° s ± í >

Ñ @ ! ÿ R s É U Í D \$

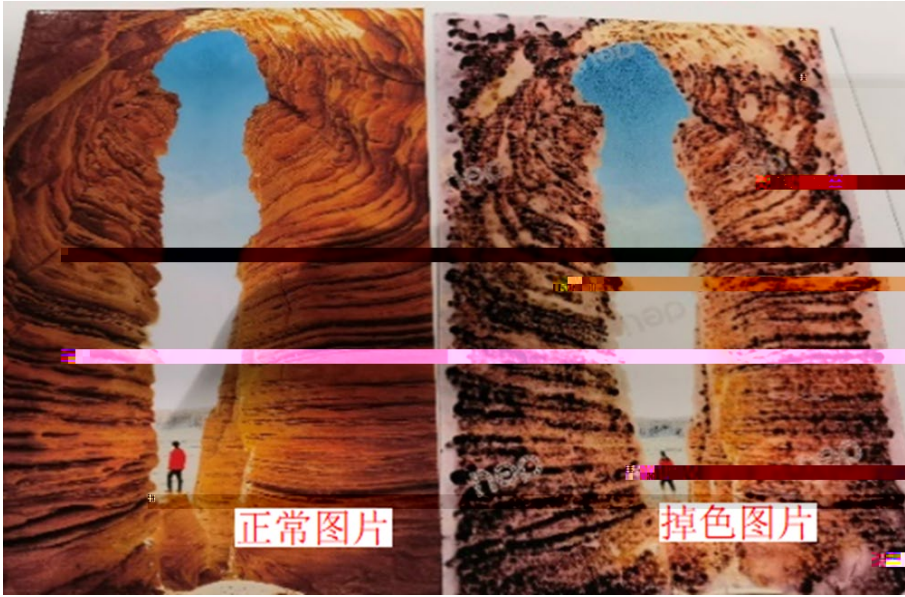

Ñ @ < R s . " < : " 7 Ö 7 A m / p " ç { ± Ö : " 7 ç æ . Å { ± — Ö
 V N % % R

1. Á ½ : 7), Z í . \$ s D Ö 3 % ± \$ % : " 7 @ ' Ñ — , ` í ñ æ Ö { " 7 A D : " 7 ! æ d — , 250g , H Æ O
 p R C : 7 Ö
2. — , : " 7 m p @ s p A ê s Ö / }) i : " 7 Ó T — , ¶ ã D æ i R
 - a) : " 7 Å Ó l p a Æ ç ^a logo D , Ê m p æ u Ö
 - b) 3 í ç ^a logo D Å Ó ç Ø p ç s p S T ñ — , Û ^m Ö ô : " 7 D ` # Z d 1 D ô m p Å " ç Å Ó ç : " 7 m
 p Ö @ % : " 7 m p / w \$ ^ Ô X D ' / ô ¶ A

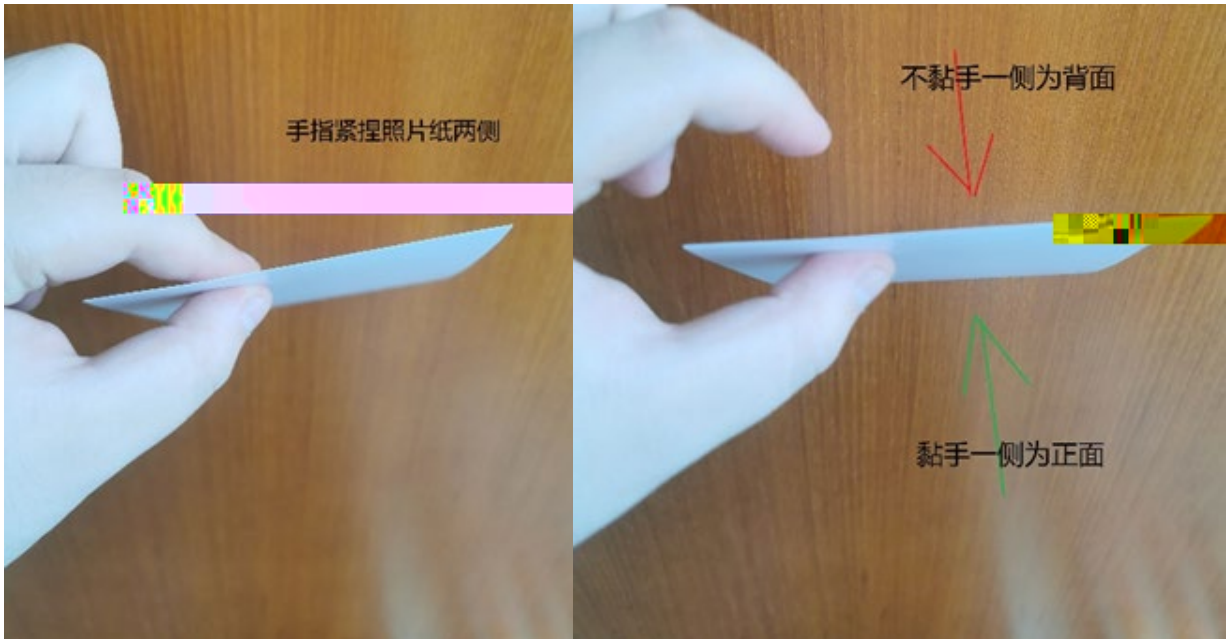

3. ; : " 7 m Á " # 7 - R Á ½ ; : " 7 m p 8 : @ T 8 Æ A D l p \$ p e " # 7 - D X Ú Å " 7 - 8 ù í p e D m Á p z :
 " 7 Ö

|*Ñ®

Í r, |*

- ; USB Ɔ•³-a 1> ¿ i'D Ö
- ipÍ ˆ USB Ɔ•D¹úÀÝt9T¹ú USB Ɔ•Ö

|* = C.

- DH yuû Ö=uû a".|* = Ö

VNÍ —, Web 2µ Ñ®

ip£—, Web 2µÚNˆÑ®D¹æ“HÇ“R

· Á½ĩ s D ˆVô³Ö

· Á½ĩ f5 ˆVô³Ö

·

3. Kms D ['½ Ö

4. KmæG@>ÖPf5æG</½ -Q@>ÚD¹ÇÚüí(Ö

žW o Ó

—,ùU 7Ñ/ÍCÔ@2)ã @p//U¼DÙÙ„Äñ â>¼ žWX%Å\D<—,ù7Ñ/ÍCÔÙÙ„Ä žW
X%Å\Ö

„ÄÚÉ? X< žWÇ¼ädëÖ

—, . ÁI žWíãöoÓZD+Đ›ÌD,ÆœÂ<Z1DDC,đjĚ6mëÖ

Q

¿ D ´ ô

| | | |
|---------|---------------|---|
| 9 ³ X | USB 9 | = = USB2.0 |
| | Í < ³ X | ³ X æ Õ R802.11b/g/n Õ © R2.4GHz œ Ð Wi-Fi Direct |
| { „ [| Windows | R d, c —, Windows [i Ç R Windows 11 @64 x A Õ Windows 10 @64 x/32 x A Windows 8.1 @64 x/32 x A Õ Windows 7 @64 x/32 x A |
| s | s ^ @ | ` 0 9 |
| | s - \ | GDI |
| 6 | 9 6 | œ Ð ô / Z í D - = 99 T |
| | ¿ T † 6 | 2 œ Ð ô D - = 99 T |
| * | * J æ Õ | ú e |
| | * ¾ 9 | CIS X 9 ~ e q |
| | * u û | ¿ Q R = 1200x1200dpi D ï R = 1200dpi |
| | * í • | D 24 x í • |
| | / — (| 256 (/ |
| D ´ | Ã „ § > “ | 5~ |
| | Ã „ ¼ > “ | 10%~80% |
| | . u Ã „ § > “ | |
| | . u Ã „ ¼ > “ | 20% ~ 80% |
| | ä û î § > “ | -25 - |
| | m Ã „ ¼ > “ | 10% ~ 93% |
| | — , [³ | 2000m H Ç |
| œ Â D ´ | œ Â æ Õ | 8 ¿ œ Â |
| | ² œ | AC 220-240V |
| | ² ³ | 50/60Hz |
| | ³ û | £ ÿ GB 21521 -2014 D |

6 •

6 HÇªËDhðm êçÖ

n~ôçÉ \$-öÖi/ªÑD¹°¥g£ñæ nFôÖ

- 7 Ò
- Æ
- ä e ö
- t @ /aT</a A
- ¿T<^pTÿœ
- <^•oT†o
- ðµ-bTf-†Q
- " Dg-0 œ TÆ
- D, Å { g/H†
- Ä ê œ
- Å ¿•
- ™ {
- 1"†Q
- —89• 9 @/aTç/a A
- á•T.ûáµd†
- 0
- <Lg/ñ~D ©Hì„Tñ@„¿