

5

4

GB 18030

4. 2. 2





---

220V

- a.
- b.
- c.
- d.
- e.
- f.
- g.

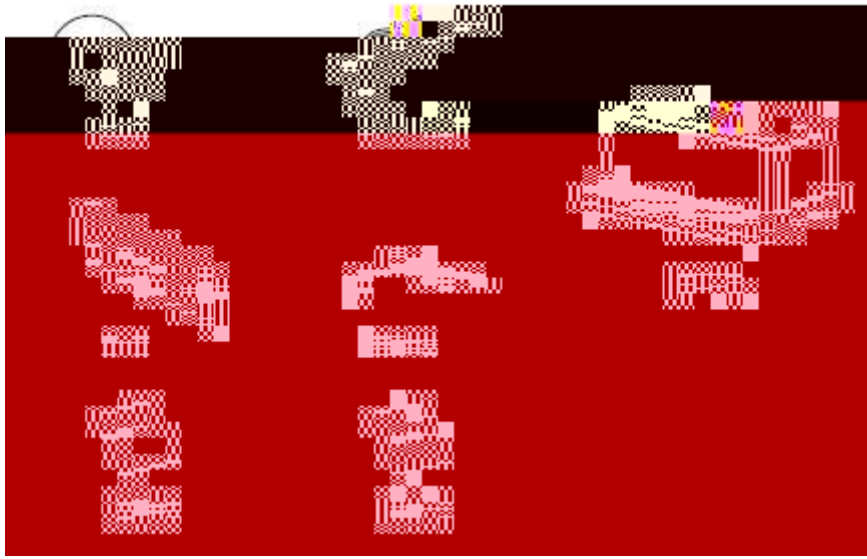

---

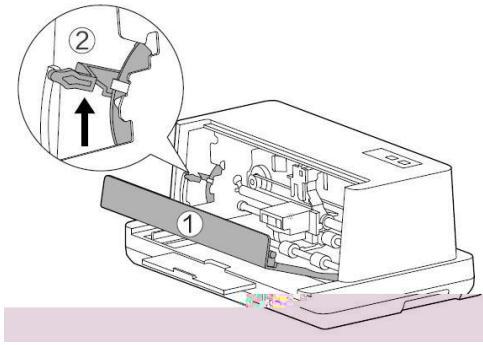

3)

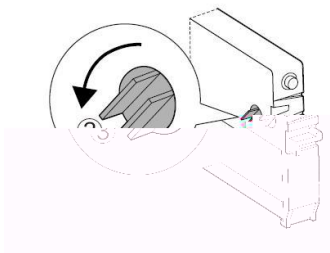

4)

a b c

,

5)

6)

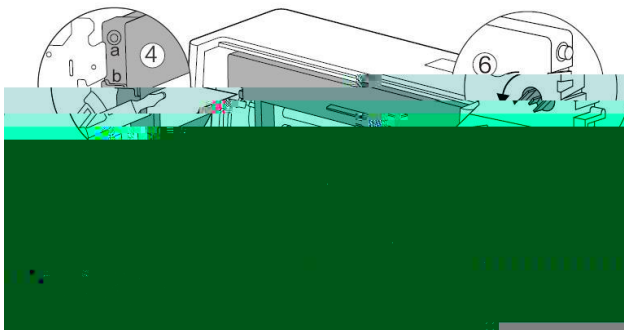

7)

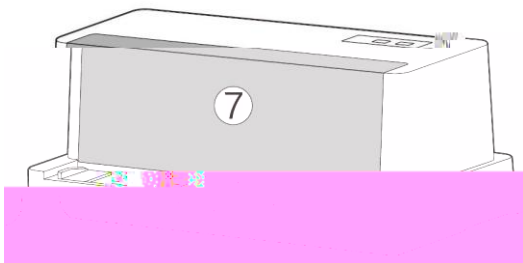



---

1)

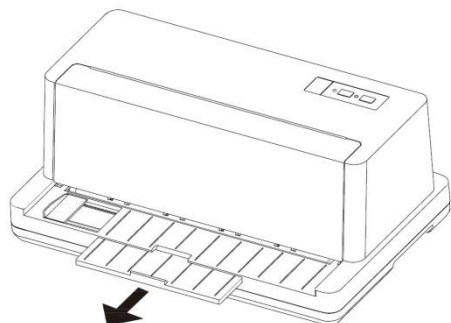

1)

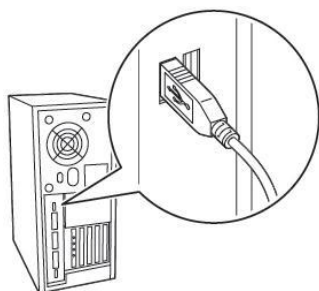

2)

USB



1)

2)

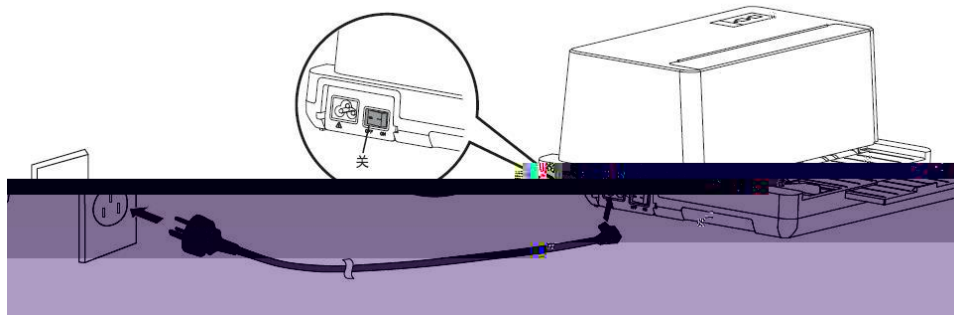

1. 5
- 2.

Windows XP / 7 / 8 / 10

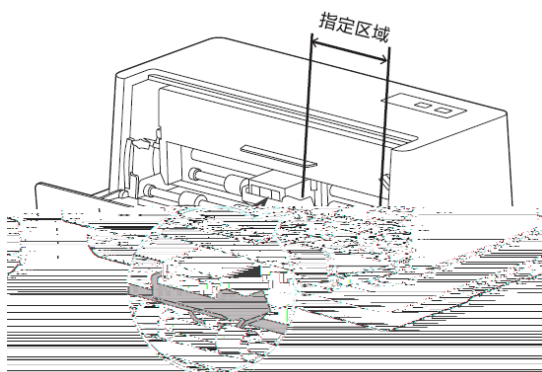

- a. \* U DeliDriver Set  
up.exe
- b. 1
- c.
- d. USB USB

---

e.

OK

Windows XP/7/8/10

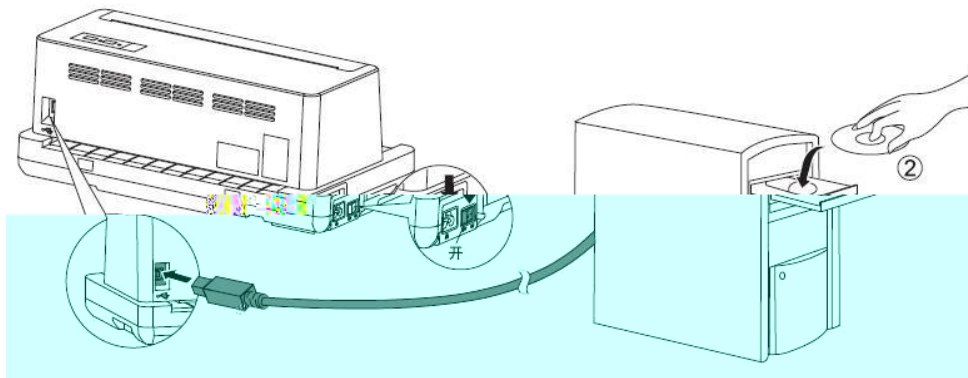

a.

DeliDriver.exe

---

1)

2)

### 2.1.1

	60	-280	/2.4	-11
	58		/2.3	
	A6		105	*148
	B6 JIS		128	*182
	A5		148	*210
	B5 JIS		182	*257
	A4		210	*297
	B4 JIS		257	*364
	Executive		7.25	*10.5
	Letter		8.5	*11
	LEGAL		8.5	*14
			30-156	/
			40-52	/
			0.07-0.18	
			0.06-0.7	

### 2.1.2

1)

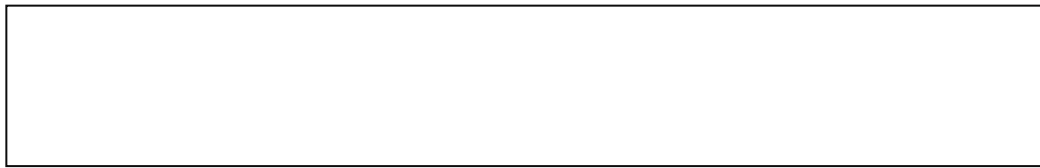
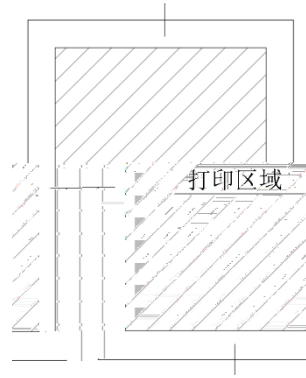

2)

11

8.2

1)

,

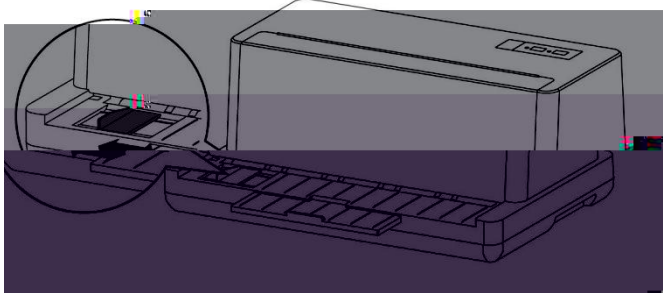

2)

3)



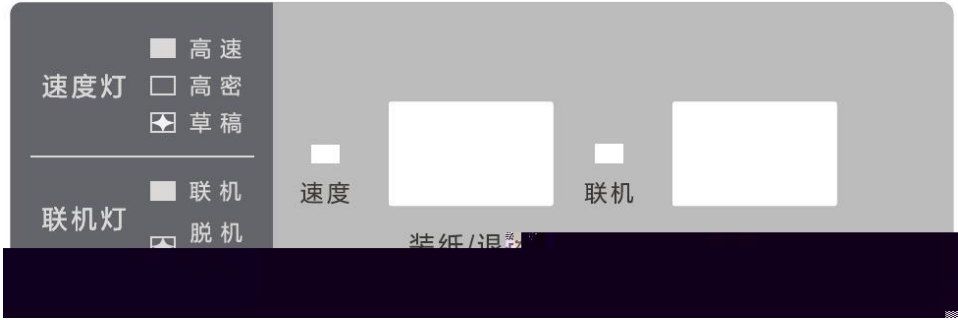

■

( )

( )



■

/

/

,

/

3

---

### 3.2.1

- ( )
- /
- /

### 3.2.2

-



---

### 3.2.3

,



ROM

EDS

■ 400EDS14 12 f0.93182 0 0 1 98.424 459.43 m( ).051 G9340021914 521881 BD B0.94 0 0 1 353.58 459.  
//

---



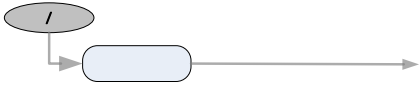

3.

4.



---

2)

---

7)

8)

9)

10)

11)

### 4.2.3

		A4	2.5      2.75      3      3.5 11/3      4      4.5      5.5 5      6      7      8      11 B5 A4 12      14
		2/12	0      1/12      2/12      3/12 4/12      5/12      6/12 7/12      8/12      9/12 10/12      11/12      12/12 13/12

---

1)

2.5      2.75      3      3.5      11/3      4      4.5  
5.5      5      6      7      8      11      B5 A4 12  
14

2)

0      1/12      2/12      3/12      4/12      5/12  
6/12      7/12      8/12      9/12      10/12      11/12  
12/12      13/12

3)

4)

5)

6)

#### 4.2.4

---

5.2

		2 2 ,
		3 3 ,
		/ /

,



---

---

---





?	

	0.7mm



# 1

## 产品中有害物质的名称及含量

部件名称	有害物质					
	铅(Pb)	汞(Hg)	镉(Cd)	六价铬 (Cr(VI))	多溴联苯 (PBB)	多溴二苯醚 (PBDE)
导线	○	○	○	○	○	○
印刷电路板	○	○	○	○	○	○
塑料	○	○	○	○	○	○
轴、金属轴	○	○	○	○	○	○
五金	○	○	○	○	○	○
其他金属	○	○	○	○	○	○

本表格依据SJ/T 11364的规定编制。

○：表示该有害物质在该部件所有均质材料中的含量均在GB/T 26572规定的限量要求以下。

×：表示该有害物质不在该部件的任一均质材料中的含量超出GB/T 26572规定的限量要求。

△：表示该有害物质不在该部件的任一均质材料中的含量超出GB/T 26572规定的限量要求。