

.....

.....

.....

.....

.....

.....

.....

.....

.....

.....

.....

.....

.....

.....

.....

.....

.....

.....

.....

.....

.....

.....

.....

1 2



:

1

2

2~3

3

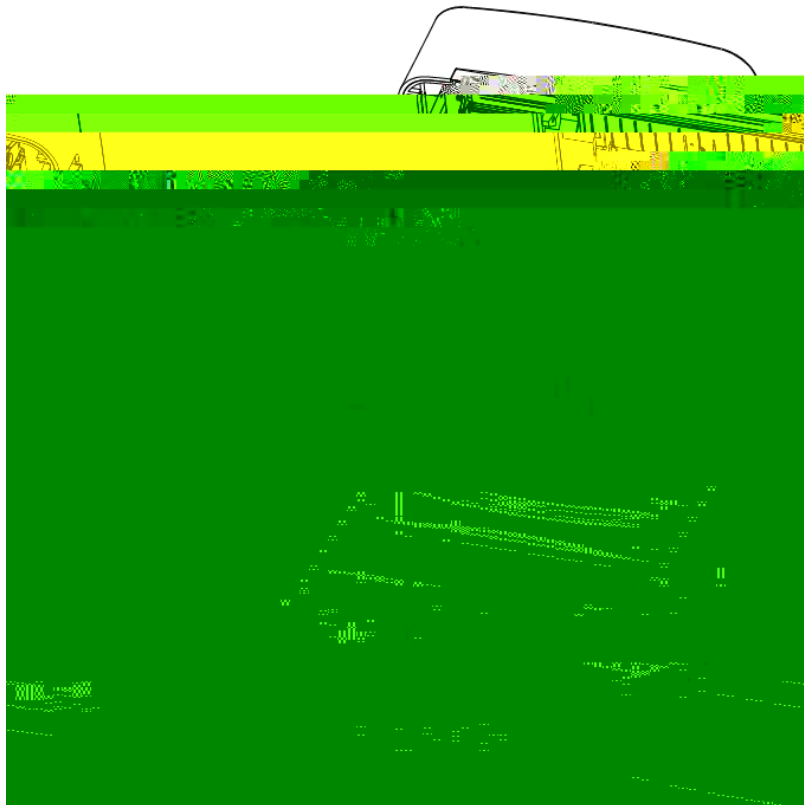
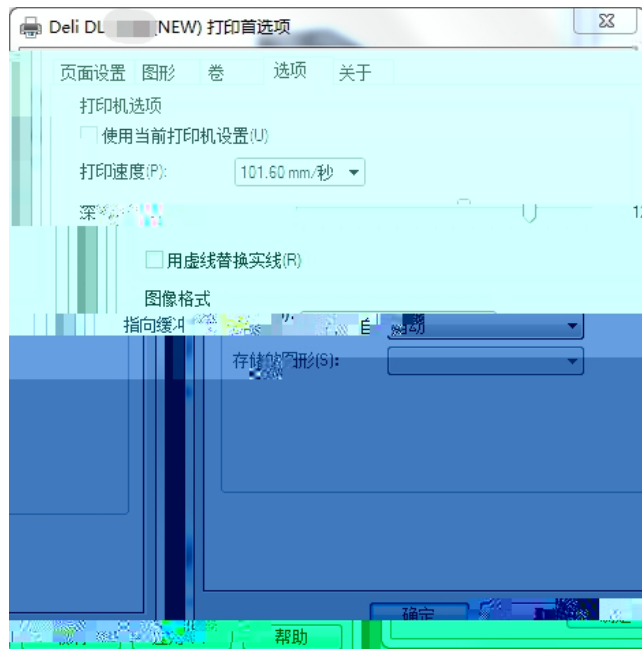



1.



2.





1

•

•

2

•

3

•

4

•

5

•

6

3.



4. WEEE()





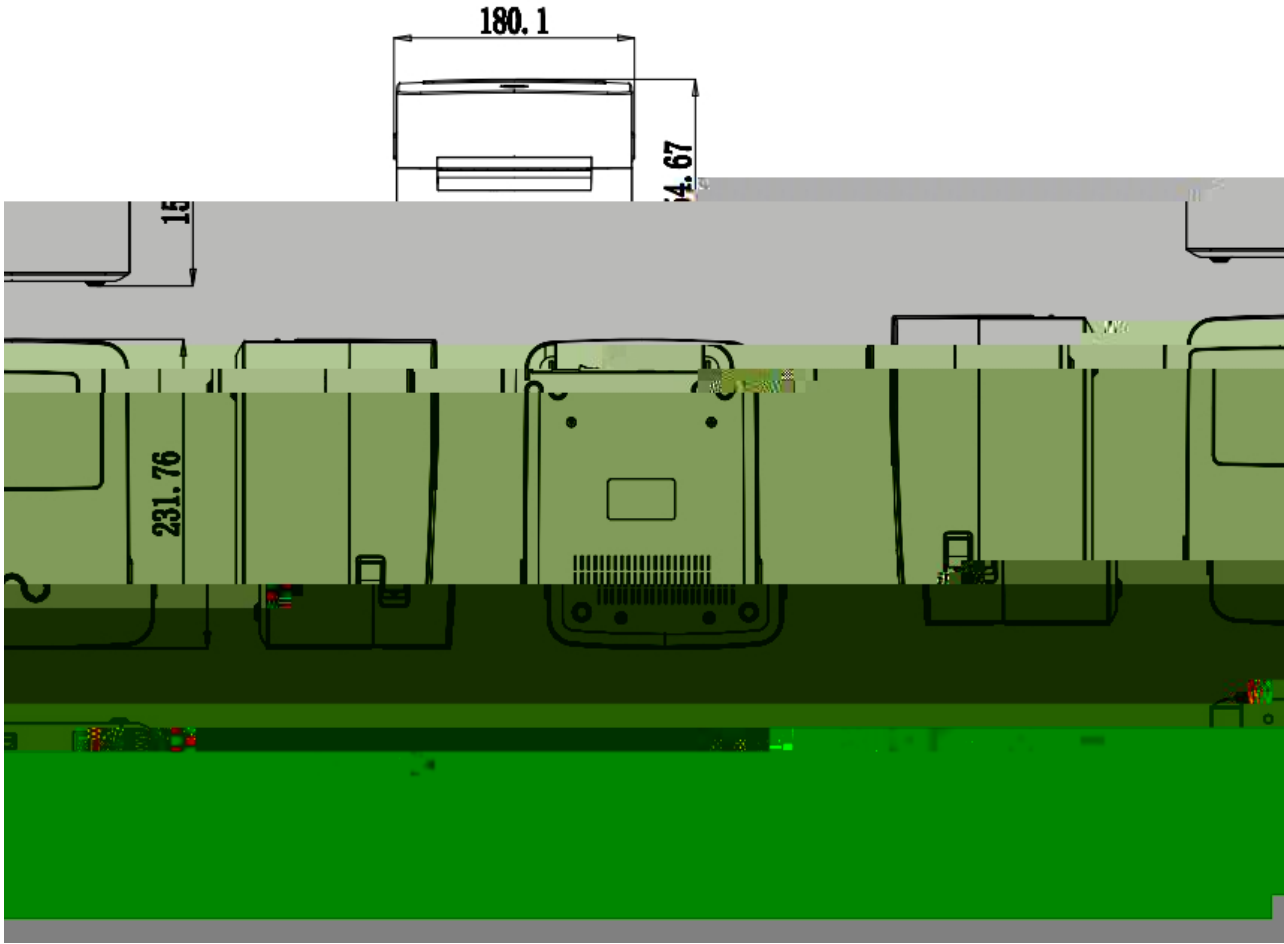



3.1.1

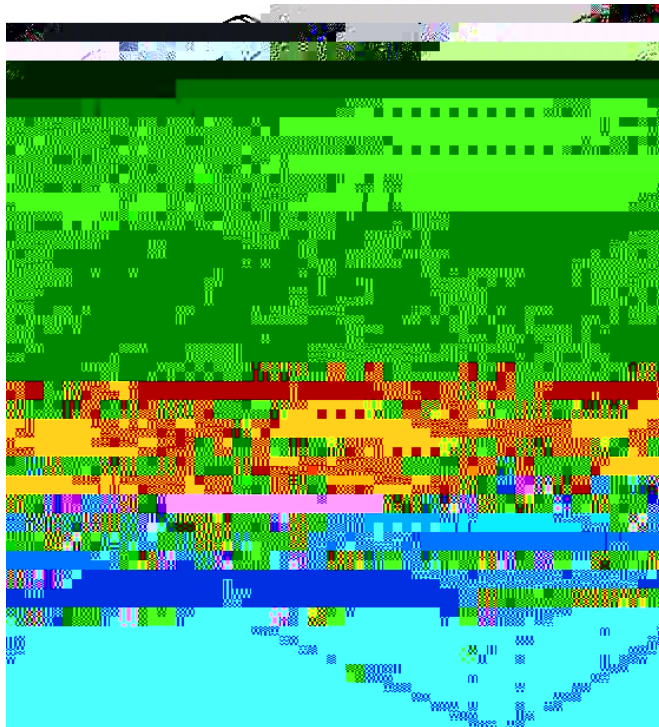
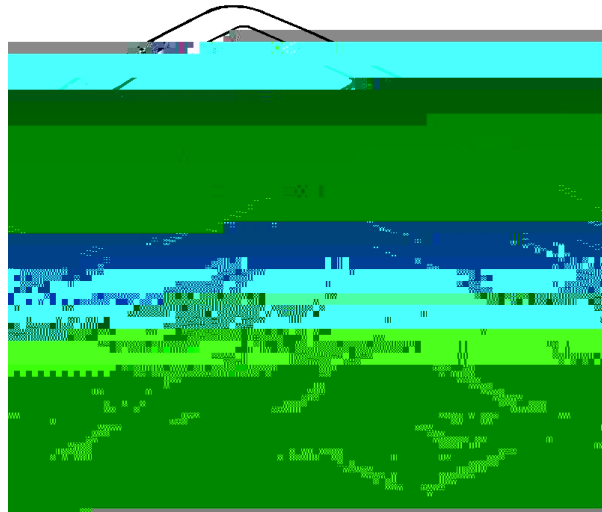

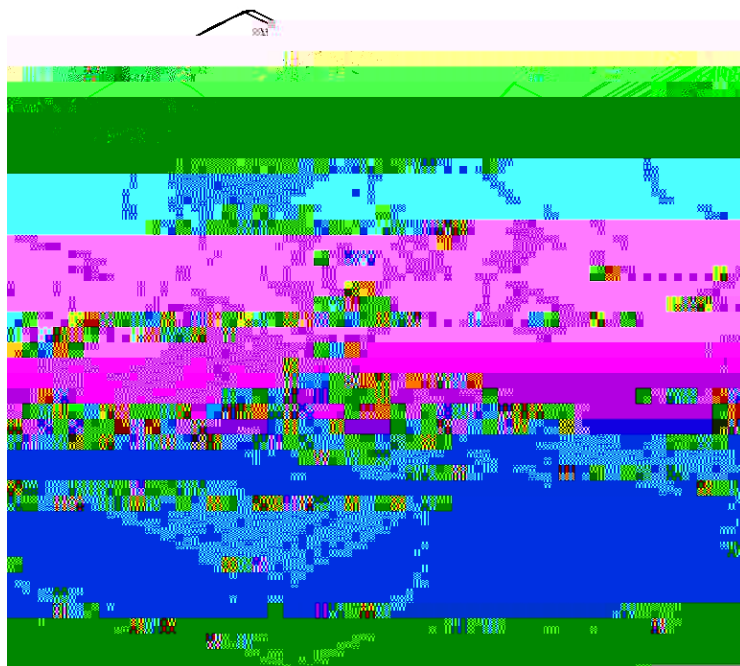
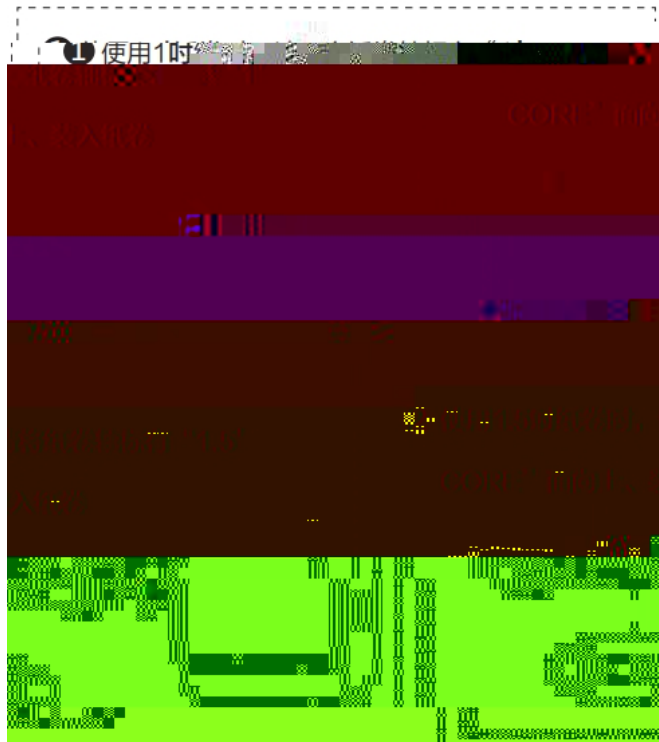

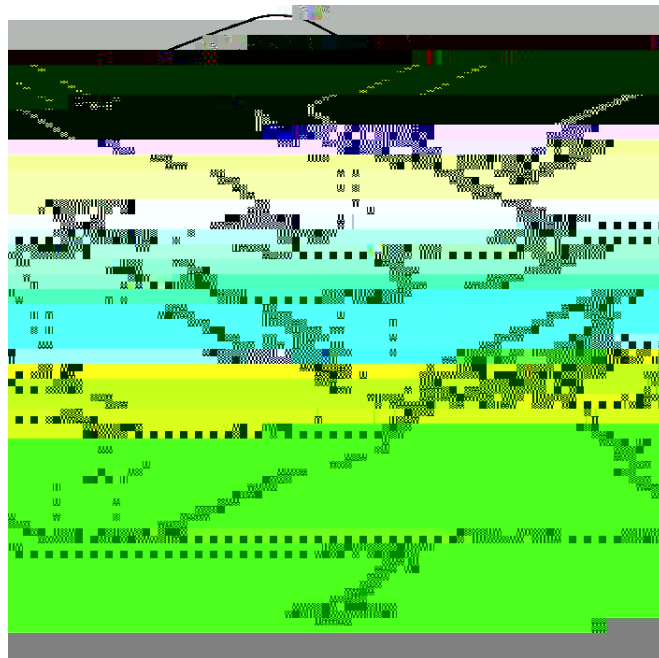
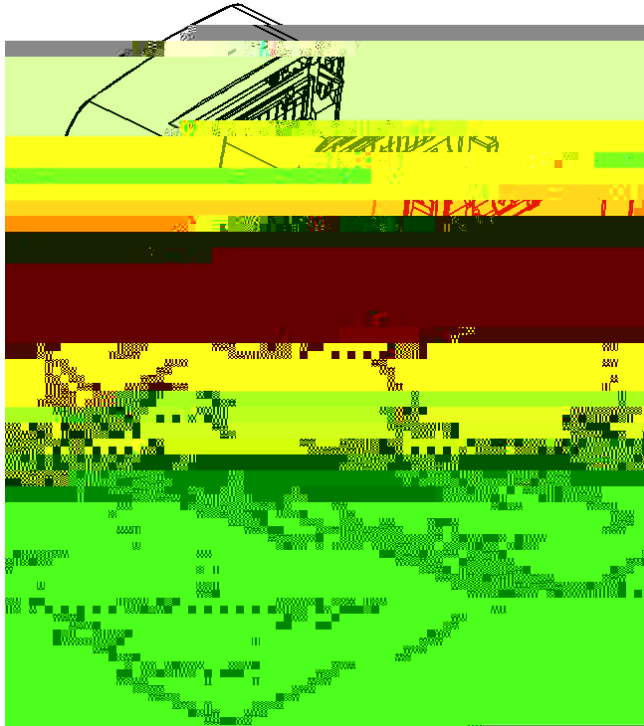

3.1.2

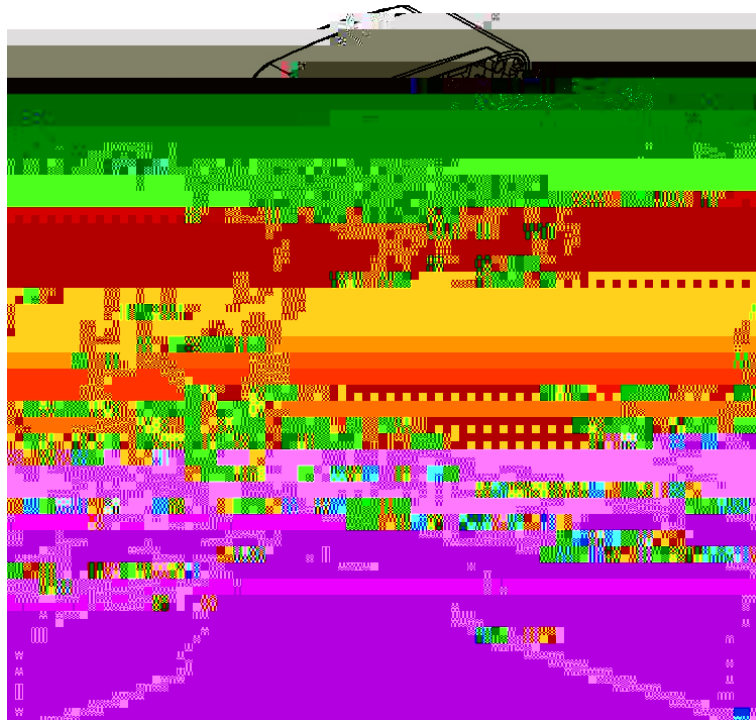
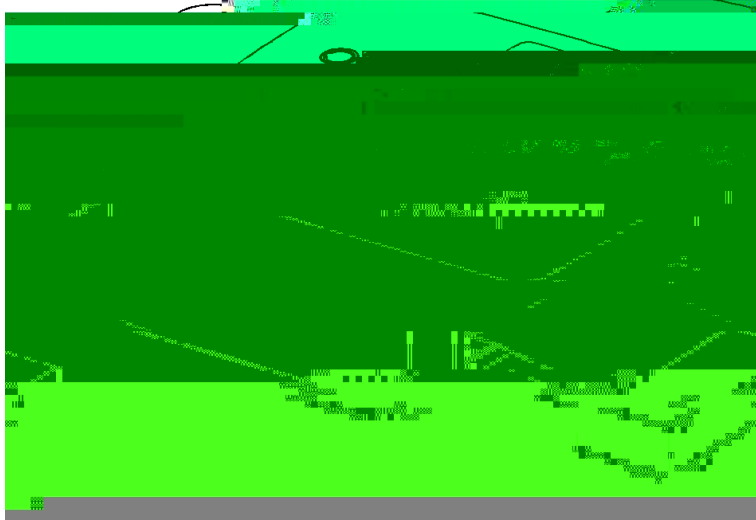

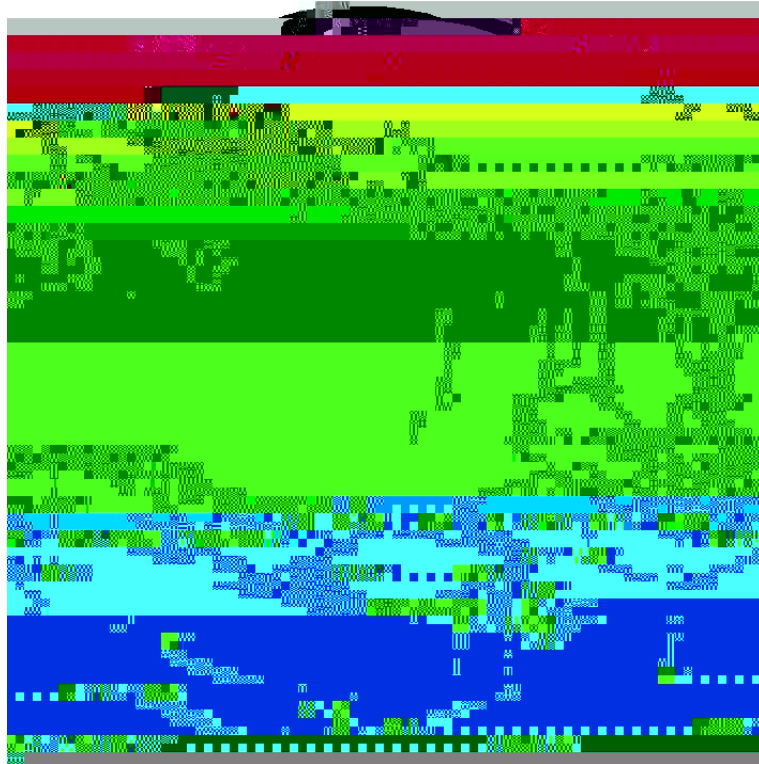

3.1.3

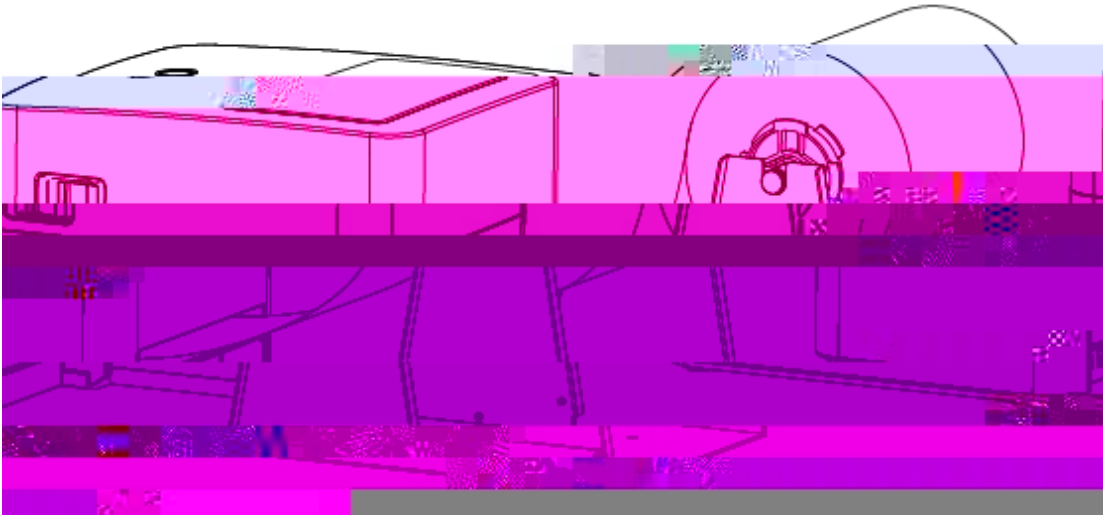

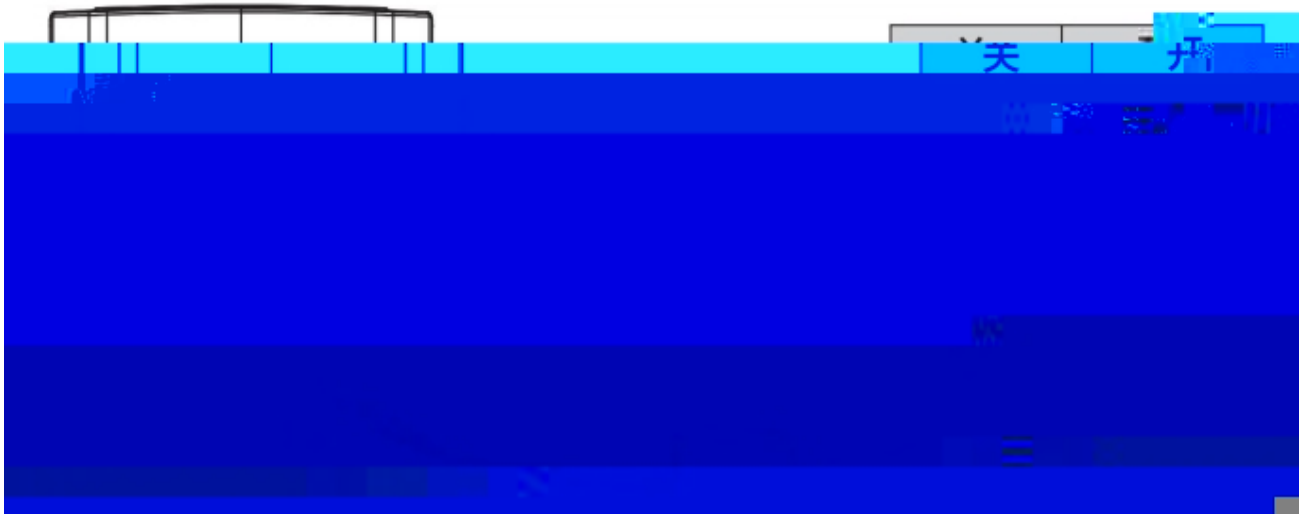

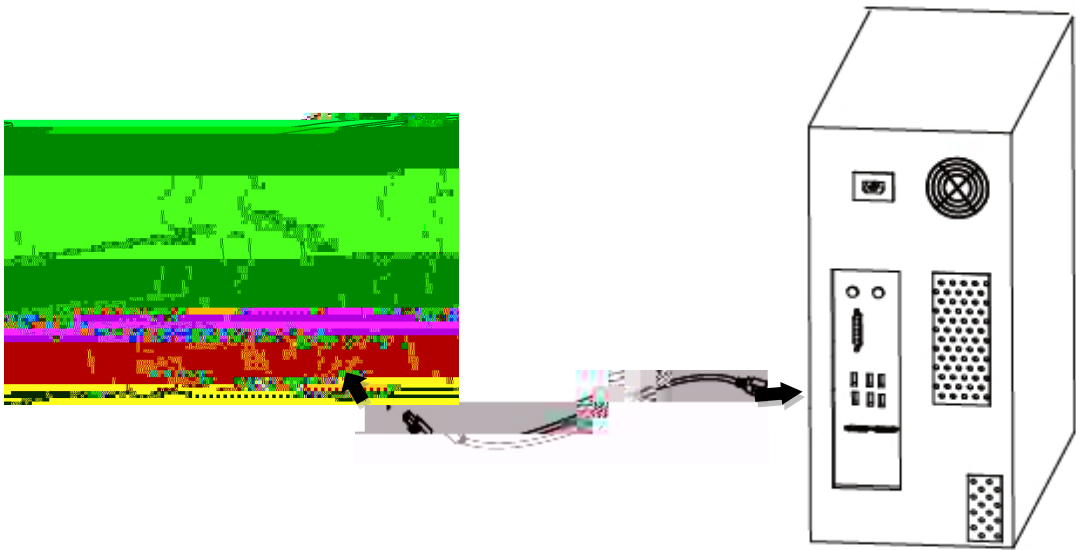

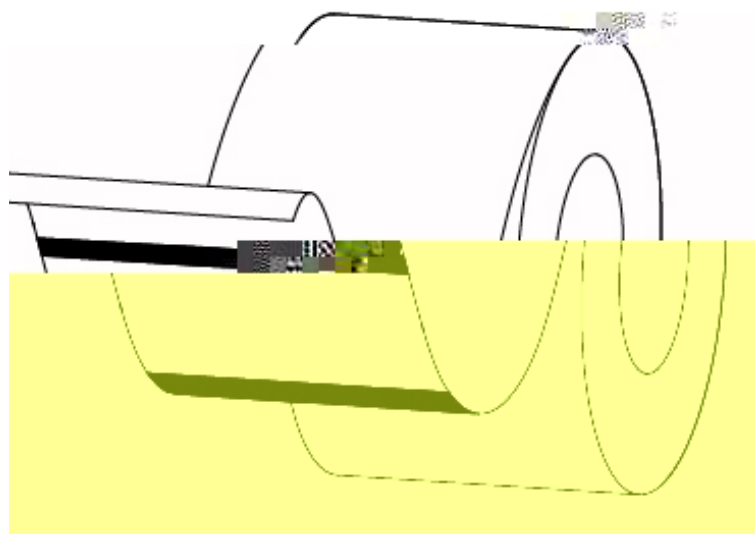
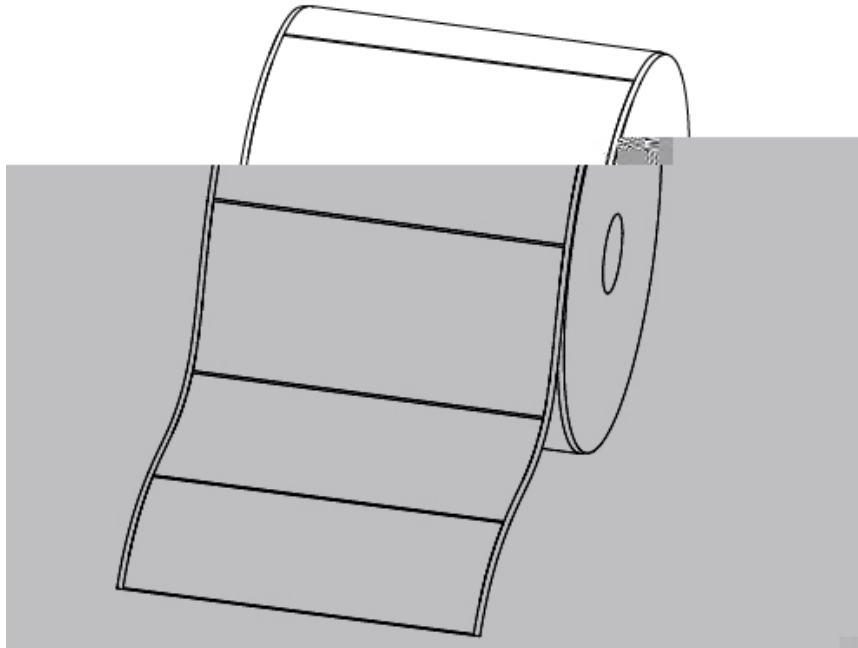



3.6.3



3.6.4

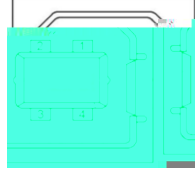

1	VBUS
2	D-
3	D+
4	GND

